



STAINLESS STEEL TRUCK ACCESSORIES





United Pacific

HOW TO ORDER

To order from United Pacific Industries, you must be an authorized dealer, distributor or OEM. If you are not authorized to stock and sell United Pacific products, you must order through an authorized dealer. Please call 800.790.6988 for more information.

CONTACT US

 8 am - 4:30 pm PST

 800.790.6988 / 562.421.3888

 888.986.5988

 Sales@upauto.com

 UPauto.com

 3788 E. Conant St., Long Beach, CA 90808

QUALITY

With over 30 years of experience in the automotive aftermarket industry, United Pacific Industries understands the rigors and stresses that our products are subjected to on the road. It is our mission to provide our customers with products of superior quality and reliability. In achieving this goal, United Pacific only partners with manufacturing facilities that conforms to our quality control requirements and standards. Our manufacturing partners meet or exceed ISO-9001 requirements. In addition, United Pacific's manufacturing partners must be equipped on site to perform the following quality assurance tests and maintain a track record of consistent quality and low product failure rate.

- Aging Test
- Air Tight Test
- Dust Test
- Flux Test
- Photometric Test
- Pull Force Test
- Rain Test
- Salt Spray Test
- Shock Test
- Temperature Test
- Humidity Test
- Vibration Test

Furthermore, our internal quality control structure allows us to function as the final quality control station prior to shipping. With the assistance of 3D computer technology, United Pacific can adhere to strict quality control standards during prototype creation and the production process. Our engineers and technicians perform a battery of tests to ensure that our products meet the demands of today's drivers and our goal to be first in quality.

INNOVATION

Known as the leader in innovation, United Pacific is dedicated to be the first to bring new and exciting products to the market. United Pacific's global expertise allows us to search the globe for new ideas and concepts. Not only do we search the globe for new products, United Pacific invest a significant amount of resources into our own research and development efforts. With the assistance of advance 3D scanning technology, our engineers and designers can acquire accurate and precise data in seconds.

The 3D data allows United Pacific to verify designs, perform quality assurance tests, and reverse engineer with unprecedented speed and accuracy. Digital inspection contributes to the early detection of shape problems, provides rapid feedback on design, and eliminates unnecessary work in downstream processes. Our rapid prototyping facility permits us to have a concept-to-shelf time of less than 5 months. In addition, United Pacific's 3D printing capabilities permit our designers to have physical models of their design concepts in hours. The physical models allow our designers and marketing staff to evaluate and test the viability of different design ideas. Our rapid prototyping facility allow United Pacific to compress design cycles, improve manufacturing planning, shorten concept-to-shelf time, most importantly, generate new and innovative products.

DESIGN

Located near some of the nation's most progressive automotive design centers, United Pacific established the UP Design Studio in 2002 to consolidate our position as the design leader in the automotive industry. UP Design Studio utilizes the latest generation of computer aided design (CAD) and studio/graphic software. The design studio is equipped with the newest computers and rapid prototyping systems. In addition, UP Design Studio is staffed by graduates from the nation's most prestigious design colleges. Unlike our competitors, United Pacific's design and manufacturing capabilities mean that we carry more new and original items than our competitors. The establishment of the design studio will enable us to generate even more new products with significant shorter concept-to-shelf time. The reduction in development cost mean that we can develop products utilizing design based development processes. Design based product development allows United Pacific to create new product concepts based on designs incorporating driver demands and needs instead of economic considerations. United Pacific's emphasis on design distinguishes and positions us ahead of our competitors.



WARRANTY

With LED (Light Emitting Diodes) rated at 100,000 hours of operation and solid-state construction, United Pacific's LED lights are extremely reliable and durable. Purchase with confidence, United Pacific offers a complete line of LED lighting products with extended or limited lifetime warranties. Please see the warranty policy page for more details.

INVENTORY AND SHIPPING

United Pacific carries over 20,000 items in our California distribution center. No other company in the heavy duty trucking industry can match United Pacific in the variety and range of in-stock inventories. With an order fill rate of over 98.5%, United Pacific is the largest and most reliable supplier in the industry. Our shipping department ships 96.8% of all orders within 24 hours and 98.9% within 48 hours. United Pacific's vast inventory and prompt shipping has made United Pacific the only source for our customer's chrome and lighting needs.



HARD AT WORK FOR THE ENVIRONMENT



United Pacific
132,000 sq ft

Distribution Center
Long Beach, CA

100% reduction in potable water used for landscaping

40% reduction in total energy use due to high-efficiency mechanical and lighting systems

82% of construction waste was diverted from landfills

LEED ACCOMPLISHMENTS

Sustainable Sites

- On-site bicycle storage, showers and changing areas for company employees.
- Preferred parking for low-emitting, fuel-efficient and carpool vehicles.
- Stormwater is infiltrated on-site and treated to remove contaminants to reduce environmental impact on local waterways.

Water Efficiency

- In addition to using reclaimed water, drought-tolerant plants and a high-efficiency irrigation system were installed to reduce the use of potable water for irrigation by 100%.

Energy and Atmosphere

- Efficient HVAC equipment and a lighting system with daylight controls reduces energy consumption by over 30%.
- Enhanced commission verifies that the building's energy and water-related systems are performing as intended by the initial design.

Indoor Environmental Quality

- Building ventilation systems was designed to provide enhanced levels of fresh outside air to building occupants.
- Interior finishes (plants, sealants, adhesives, coatings, carpet systems and composite wood) were selected with low levels of volatile organic compounds (VOCs) to reduce indoor air contamination.





430 SS Bug Deflector with Hood Tilt Handle for 2018-2022 Freightliner Cascadia

- Highly polished 430 stainless steel
- Includes sturdy built in grab handle for hood tilt
- Requires drilling holes for installation
- Installation hardware included

29150 1 Pc. / Box



Stainless Steel Bug Deflector for 2013+ Freightliner Coronado SD

- Highly polished 430 stainless steel
- Mounting holes pre-punched for easy installation
- Drilling required for mounting
- Installation hardware included

29100 1 Pc. / Box



**Stainless Steel Bug Deflector for 2010+
Freightliner Coronado**

- Highly polished 430 stainless steel
- Mounting holes pre-punched for easy installation
- Drilling required for mounting
- Installation hardware included

29097 1 Pc. / Bulk



**Stainless Steel Bug Deflector for 2008+
Freightliner Cascadia**

- Highly polished 430 stainless steel
- Mounting holes pre-punched for easy installation
- Drilling required for mounting
- Installation hardware included

29090 1 Pc. / Box



FREIGHTLINER

Bug Deflectors



Stainless Steel Bug Deflector for Freightliner FLD 120/112

- Highly polished 430 stainless steel
- Mounting holes pre-punched for easy installation
- Drilling required for mounting
- Installation hardware included

29093 1 Pc. / Box



Stainless Steel Bug Deflector for 2008+ Freightliner Columbia

- Highly polished 430 stainless steel
- Mounting holes pre-punched for easy installation
- Drilling required for mounting
- Installation hardware included

29092 1 Pc. / Box



Stainless Steel Bug Deflector for Freightliner Classic/Classic XL

- Highly polished 430 stainless steel
- Mounting holes pre-punched for easy installation
- Drilling required for mounting
- Installation hardware included

29094 1 Pc. / Box



Stainless Steel Bug Deflector for 2005+ Freightliner Century

- Highly polished 430 stainless steel
- Mounting holes pre-punched for easy installation
- Drilling required for mounting
- Installation hardware included

29091 1 Pc. / Box



430 Stainless Steel Grille Surround with Hood Tilt Handle for 2018-2022 Freightliner Cascadia

- Highly polished 430 stainless steel
- Provides protection against road debris
- Enhanced additional protection with side grille deflectors
- Requires drilling holes in hood to install
- Features sturdy built in grab handle for hood tilting
- Hardware included for installation

29152 6 Pc. / Box

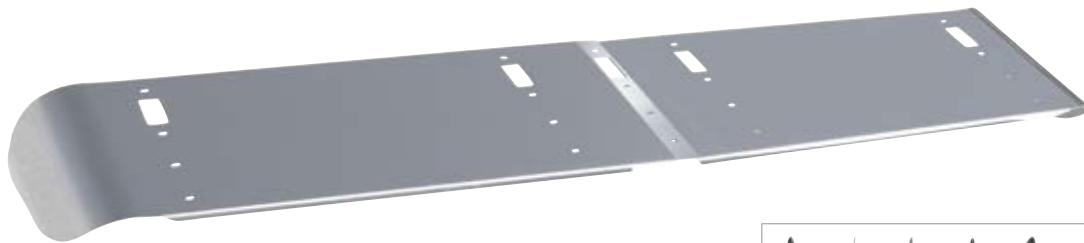

430 Stainless Steel Sunvisor for 2014-2022 Freightliner Cascadia With Raised/Mid-Roof

- Highly polished 430 stainless steel
- Sunvisor includes cutouts for OEM lights
- Requires drilling holes in roof to install
- Hardware included for installation
- Not compatible with DayCab models

29151 9 Pc. / Box



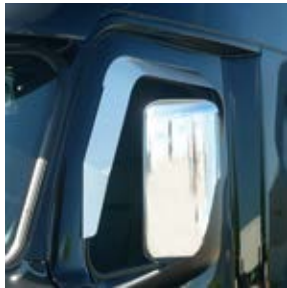

430 Stainless Steel Window Shade/Wind Deflector for 2018-2022 Freightliner Cascadia

- Highly polished 430 stainless steel
- Includes brackets for passenger door mirror
- Easy mounting with 3M double sided tape

29147 Shade/Wind Deflector - 1 Pair. / Card



430 Stainless Steel Window Shade/Wind Deflector for 2008-2017 Freightliner Cascadia

- Highly polished 430 stainless steel
- Includes brackets for passenger door mirror
- Easy mounting with 3M double sided tape

29148 Shade/Wind Deflector - 1 Pair. / Card



Light & CB Antenna Bracket For 2018-2022 Freightliner Cascadia

- Highly polished 304 premium grade stainless steel for durability and shine
- Stainless steel bracket for single stud pedestal light, and CB antenna
- Mounts onto mirror arm. Simply remove two mirror arm mounting screws, install the bracket, and reinstall the longer screws included

42376 Driver Side - 1 Pc. / Box

42377 Passenger Side - 1 Pc. / Box



Stainless Steel Antenna Bracket for Freightliner Cascadia Light

- Stainless steel single stud Pedestal light and CB antenna bracket for Freightliner Cascadia
- Mounts onto various Freightliner Cascadia trucks
- Sold individually, please specify LH or RH

42374 Driver Side - 1 Pc. / Box

42375 Passenger Side - 1 Pc. / Box



Stainless Steel Lower Sleeper Window Trim for Freightliner

- Highly polished 430 stainless steel
- Mounting holes pre-punched for easy installation
- Drilling required for mounting
- Installation hardware included

21724 1 Pc. / Skin Pack



Stainless Steel Curved View Window Trim for Freightliner

- Highly polished stainless steel
- Sealant adhesive included

21719 1 Pc. / Bulk

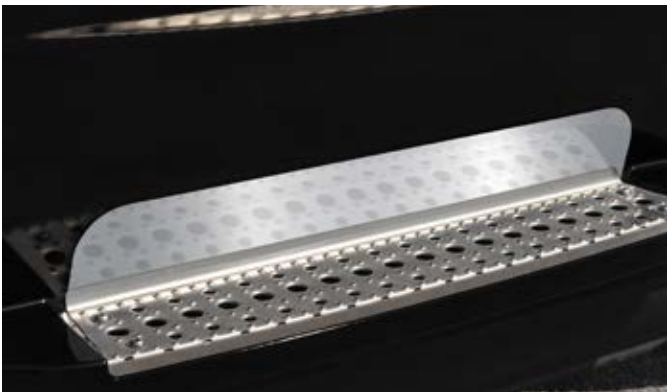

430 Stainless Steel Lower Step Surface Protective Plates for 2018-2022 Freightliner Cascadia

- Highly polished 430 stainless steel
- Protects paint from scratches and scuffs
- Clean surface recommended for installation
- Easy installation with 3M double sided tape
- Not for trucks equipped with lane departure sensor

29153 1 Pair / Card

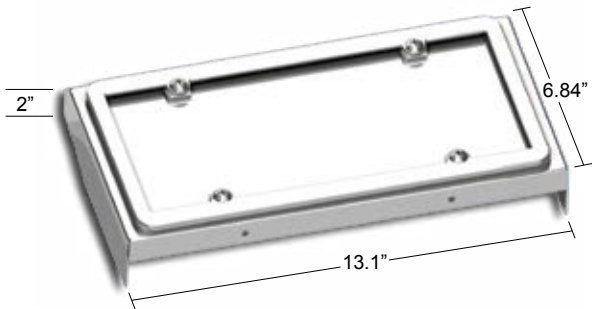

Stainless Steel License Plate Holder for 2008-2017 Freightliner Cascadia

- Highly polished 430 stainless steel
- Mounting holes pre-punched for easy installation
- Drilling required for mounting
- Installation hardware included

29098 1 Pc. / Box

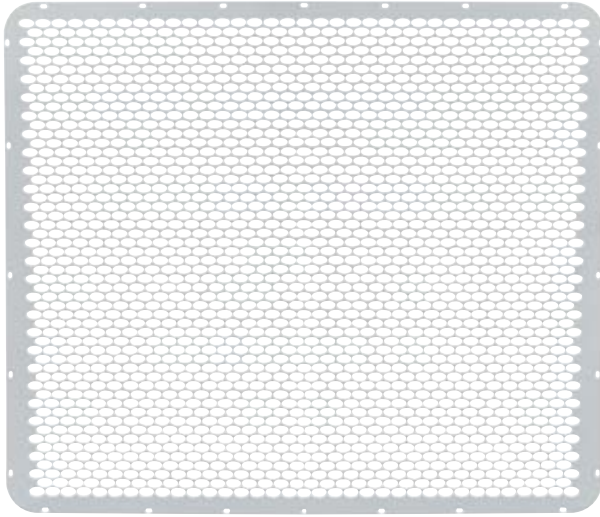

Extended Hood Stainless Steel Grille with Oval Holes for Peterbilt 379

- Highly polished 430 stainless steel
- Fits 127" extended hood, long nose grille with oval cutout
- Alternating hole pattern
- Installation hardware included

21061 1 PC. / Box

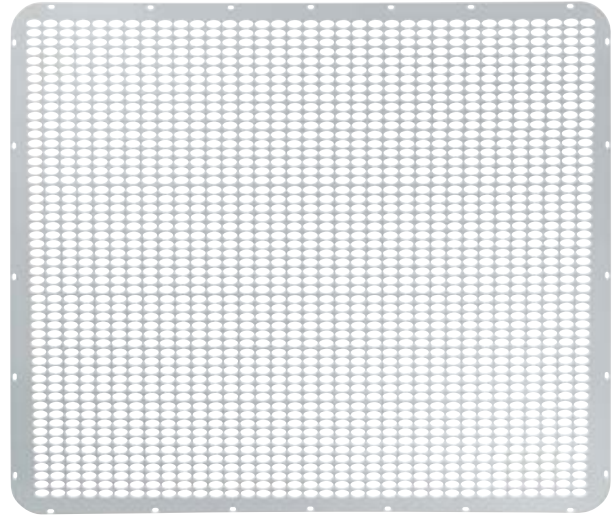

Extended Hood Stainless Steel Grille with Straight Holes for Peterbilt 379

- Highly polished 430 stainless steel
- Fits 127" extended hood, long nose grille with oval cutout
- Straight hole pattern
- Installation hardware included

21062 1 Pc. / Box

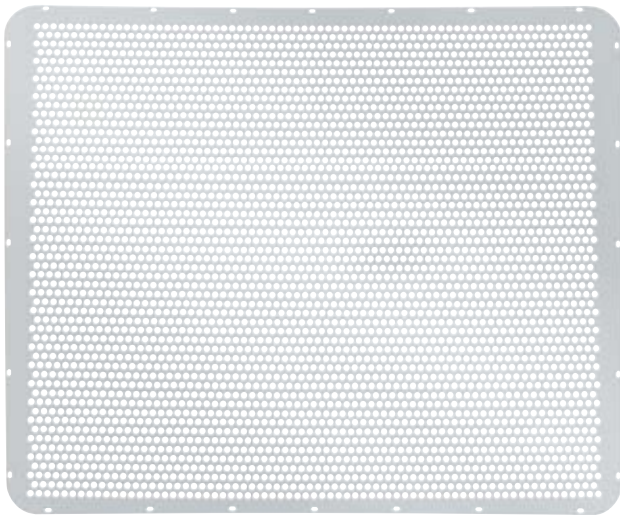

Extended Hood Stainless Steel Grille with Round Holes for Peterbilt 379

- Highly polished 430 stainless steel
- Fits 127" extended hood, long nose grille with round cutout
- Alternating hole pattern
- Installation hardware included

21063 1 PC. / Box

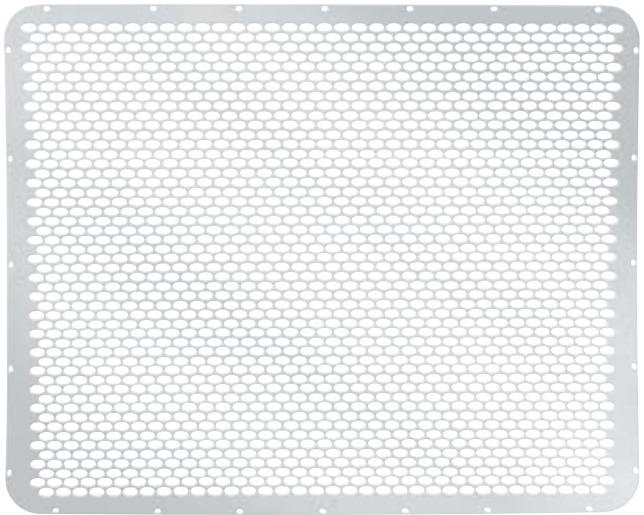

Extended Hood Stainless Steel Grille with Oval Holes for Peterbilt 379

- Highly polished 430 stainless steel
- Mounting holes pre-punched for easy installation
- Drilling required for mounting
- Installation hardware included

21064 1 Pc. / Box

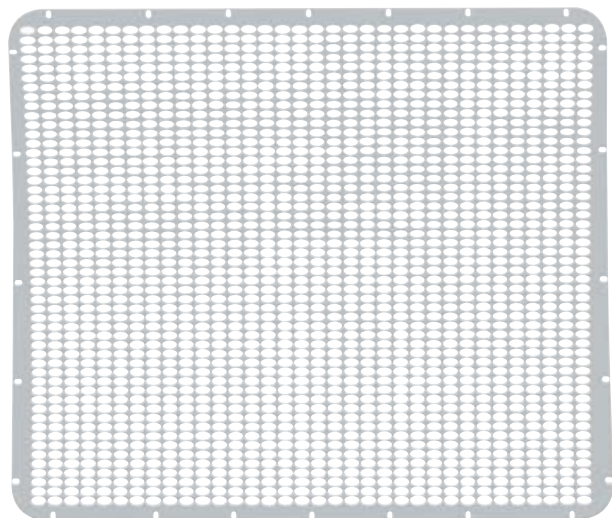

**Stainless Steel Grille for Extended Hood
Peterbilt 379**

- Highly polished 304 stainless steel
- Fits 127" hood, long nose grille with oval cutout

21151 1 Pc. / Box

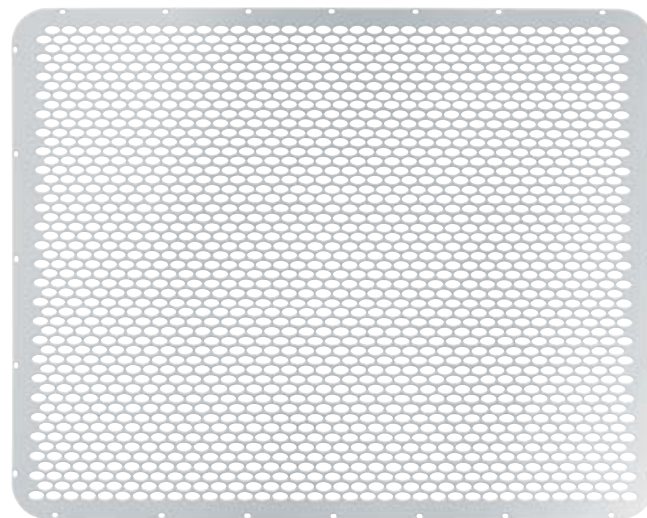

**Stainless Steel Grille with Alternating Oval Holes
For Short Hood Peterbilt 379**

- Highly polished 304 stainless steel
- Fits short nose grille with oval cutout

21152 1 Pc. / Bulk

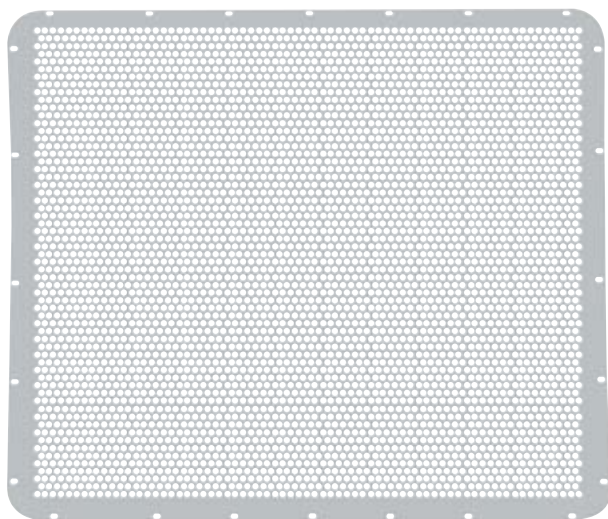

**Stainless Steel Grille with Alternating Round Holes
for Extended Hood Peterbilt 379**

- Highly polished 304 stainless steel
- Fits 127" hood, long nose grille with 7/16" cutout

21153 1 Pair / Box

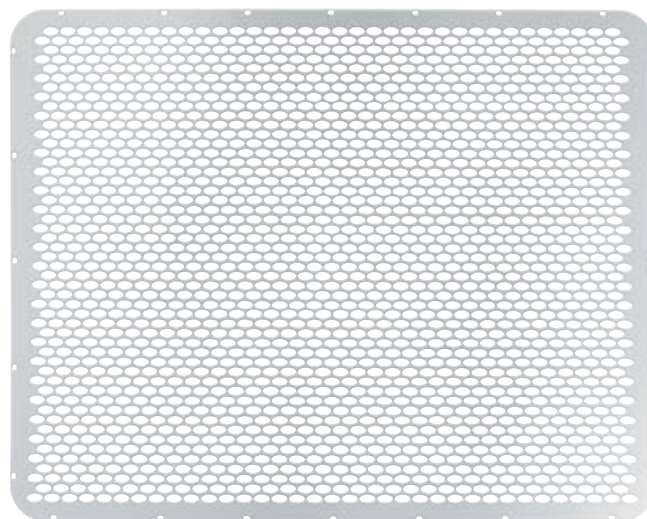

**Stainless Steel Grille with Straight Oval Holes for
Extended Hood Peterbilt 379**

- Highly polished 304 stainless steel
- Fits 127" hood, long nose grille with oval cutout

21154 1 Pair / Box

PETERBILT

Grille Bars & Side Grille Deflector



Stainless Steel 33 1/2" Grille Bar for Peterbilt/Kenworth

- Highly polished stainless steel
- OEM style
- Bolt mount included

21160 1 Pc. / Box



Stainless Steel 34" Grille Bar for Peterbilt 379

- Highly polished 304 stainless steel
- For Peterbilt 379 and various other models
- OEM style 34" length x 1-3/4" width, mounting hardware included

21166 1 Pc. / Bulk



Stainless Steel 34" Grille Bar Cover for Peterbilt

- Highly polished 304 stainless steel
- OEM style & size, fits over original bar
- 34 x 1-3/4" hollow back, mounting hardware included

21165 1 Pc. / Box



Stainless Steel Side Grille Deflector for Peterbilt 379 W/ 4 Headlight System

- Highly polished stainless steel
- Mounting hardware included
- Without LED cutouts

20695 1 Pair / Card



Stainless Steel Bug Deflector for 2014+ Peterbilt 567

- Highly polished 430 stainless steel
- Mounting holes pre-punched for easy installation
- Drilling required for mounting
- Installation hardware included

29134 1 PC. / Box



Stainless Steel Bug Deflector for 2013+ Peterbilt 579

- Highly polished 430 stainless steel
- Mounting holes pre-punched for easy installation
- Drilling required for mounting
- Installation hardware included

29001 1 Pc. / Box



Stainless Steel Bug Deflector for Peterbilt 386

- Highly polished 430 stainless steel
- Mounting holes pre-punched for easy installation
- Drilling required for mounting
- Installation hardware included

29002 1 Pc. / Box



Stainless Steel Bug Deflector for 2007+ Peterbilt 388/389 Heavy Haul 367

- Highly polished 430 stainless steel
- Mounting holes pre-punched for easy installation
- Drilling required for mounting
- Installation hardware included

29003 1 Pc. / Box

PETERBILT

Bug Deflectors / Window Trim / Sunvisor



Stainless Steel Long Hood Model Bug Deflector for Peterbilt 379

- Highly polished 430 stainless steel
- Mounting holes pre-punched for easy installation
- Drilling required for mounting
- Installation hardware included

29000 1 Pc. / Box

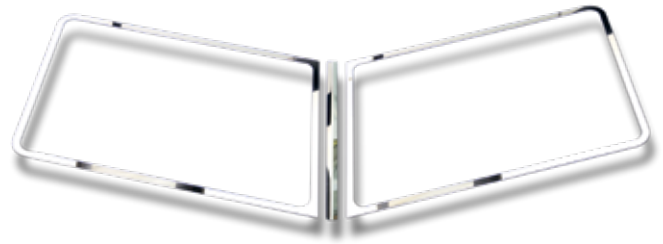

Stainless Steel 3 Pc. Windshield Trim for 1987+ Peterbilt 379/386/388/389

- Highly polished 430 stainless steel
- Completely covers the outer trim of the front windshield
- Easy installation with included double sided tape

29130 1 Pc. / Bulk



430 Stainless Steel Bug Deflector for Peterbilt 378/379 Short Hood and 357

- Highly polished 430 stainless steel
- Requires drilling holes in hood to install
- Hardware included for installation

29018 1 Pc. / Box



430 Stainless Steel Bug Deflector for Peterbilt 379 Long Hood

- Highly polished 430 stainless steel
- Requires drilling holes in hood to install
- Hardware included for installation

29019 1 Pc. / Box

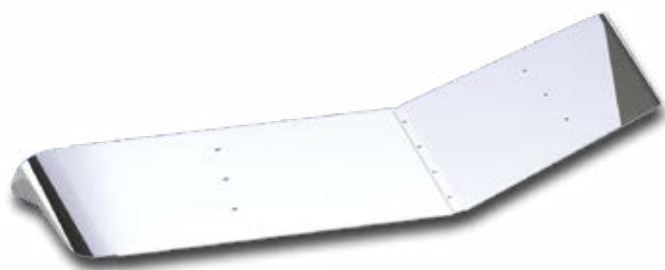

Stainless Steel Plain Style Sunvisor for 2005+ Peterbilt 379/388/389/367 with Standard Cab 12" Extended - Non Louvered

- Highly polished 430 stainless steel

29128 1 Pc. / Box

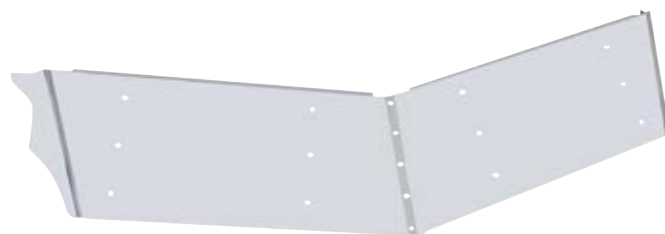

Stainless Steel 13" Drop Sunvisor for Standard Cab Peterbilt 379/385/357

- Highly polished 430 stainless steel

28006 1 Set / Box



Stainless Steel 13" Low Roof Drop Sunvisor for 2004+ Peterbilt

- Highly polished 430 stainless steel
- Fits various 2004 and newer Peterbilt models

28008 1 Set / Box



Stainless Steel 13" Low Roof Drop Sunvisor w/ Ten 2" Light Cutouts for 2004+ Peterbilt

- Highly polished stainless steel
- Fits various 2004 and newer Peterbilt models

28009 1 Set / Box

PETERBILT

Sunvisor / Grille Guard / Fender Guards



Stainless Steel 14" Drop Sunvisor for 1997-2001 Ultra Cab Peterbilt 379 & 379X

- Highly polished stainless steel
- Complete kit with stainless steel bracket

28011 1 Set / Box



Stainless Steel 14" Ultra Cab Drop Sunvisor for 2002+ Peterbilt 379

- Highly polished stainless steel
- Complete kit with stainless steel bracket

28015 1 Set / Box

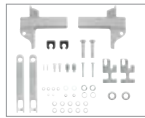

Grille Guard Mounting Bracket Set for Peterbilt 57 (2021-2021), 2008-2017 Kenworth T660

- Durable steel construction with zinc plated hardware. Easy installation on OEM tow hook receivers
- Bracket set designed for grille guard to tilt forward for easy access to bumper, grille and lights, and clears hood when opening
- Instruction sheet included. For use with Grille Guard #80000
- Note: Installation requires access to tow hook receivers on frame through original bumper. If using aftermarket bumper, be sure that the tow hook receivers are accessible
- Installation requires use of vehicles original tow hook pins
- May not be compatible with trucks equipped with electronic sensors, radar, VORAD systems

80003 1 Set / Box



Stainless Steel Fender Guard for 2007+ Peterbilt 388/389

- Highly polished 430 stainless steel
- Mounts on the fender below the headlight
- Die stamped to match the curve of the fender section with pre-punched rivet holes
- Drilling required for mounting

29129 1 Pair / Box



Stainless Steel Front Fender Guards for Peterbilt 370

- Highly polished stainless steel

20585 1 Pair / Box



Stainless Steel Fender Guards for 1986+ Peterbilt 378/349

- Highly polished 18 gauge 304 stainless steel
- Some drilling may be required for installation
- Mounting hardware included

20572 1 Pair / Box



Stainless Steel Fender Guard with Headlight Mount for 1986+ Peterbilt 378/379

- Highly polished 304 stainless steel
- Some drilling may be required for installation
- Mounting hardware included

20584 1 Pair / Box



Stainless Steel Vent Door Cover and Dimpled Trim Set for Peterbilt

- Highly polished stainless steel
- Fits Peterbilt without Louver
- Set includes 2 vent door covers and 2 dimpled trims

20562 4 Pcs. / Card

PETERBILT

Vent Door Cover / Window Trim



Stainless Steel Dimpled Vent Door Trim for Peterbilt

- Highly polished stainless steel
- Mounting hardware included
- Set includes 2 dimpled vent door trims

20565 2 Pcs. / Card



Stainless Steel External View Window Cover for 2005+ Peterbilt

- Highly polished stainless steel
- Includes adhesive backing

21741 1 Pc. / Skin Pack



Stainless Steel Vent Door Cover for Peterbilt 359/377 and 379

- Highly polished stainless steel
- 9" x 3 3/4"

20518 2 Pcs. / Card



Stainless Steel Oval Window Trim for Peterbilt

- Highly polished stainless steel
- Fits various Peterbilt models
- Includes sealant adhesive

21718 1 Pc. / Bulk

Stainless Steel Rear Sleeper Window Trim for Peterbilt

- Highly polished stainless steel
- 36" x 19" center to center

21723B 1 Pc. / Card

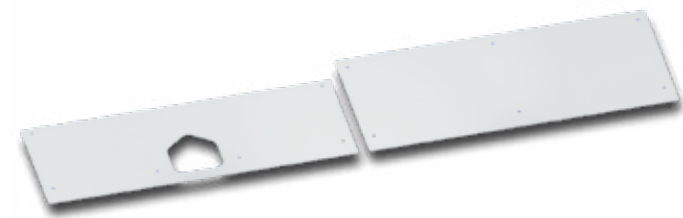

Stainless Steel Battery & Tool Box Panel for 1993 - 2007 Peterbilt 378/379

- Highly polished 430 stainless steel
- Features pre-punched rivet mounting holes
- Laser cut pocket for tool box access T-handle

29133 1 Set / Box



Stainless Steel Sleeper Shock Cover for Peterbilt

- Highly polished stainless steel
- Includes double sided tape

20610 1 Pc. / Card



Stainless Steel 7" Chopped Window Trim for 2005+ Peterbilt 379/386/389/ and various other Peterbilt models with cab mounted mirrors

- Highly polished 304 stainless steel
- Easy to install pressure sensitive adhesive mounting
- Includes 1 piece lefthand trim, 1 piece righthand trim

29096 1 Pair / Box



Stainless Steel 5" Chopped Window Trim for 2005+ Peterbilt 379/386/389

- Highly polished stainless steel
- Fits 2005+ Peterbilt 379/386/389 and various other Peterbilt models with cab mounted mirrors
- Sold in pairs

29095 1 Pair / Box

PETERBILT

Window Accent / Door Accents / Step Trim



Stainless Steel Door Window Shadow for Peterbilt 567/579 & Kenworth T680/T880

- Highly polished 430 stainless steel
- Laser cut to match the curvature of the door window frame

29135 1 Pair / Box



Stainless Steel Door Window Accent for Peterbilt 579

- Highly polished 430 stainless steel
- Attaches using supplied 3M two-sided tape
- Sold in pairs

29026 1 Pc. / Box



Stainless Steel Door Window Accent for Peterbilt 387, 2011+ Peterbilt 587 & Kenworth T700

- Highly polished 430 stainless steel
- Attaches using supplied 3M two-sided tape
- Sold in pairs

29046 1 Pair / Card

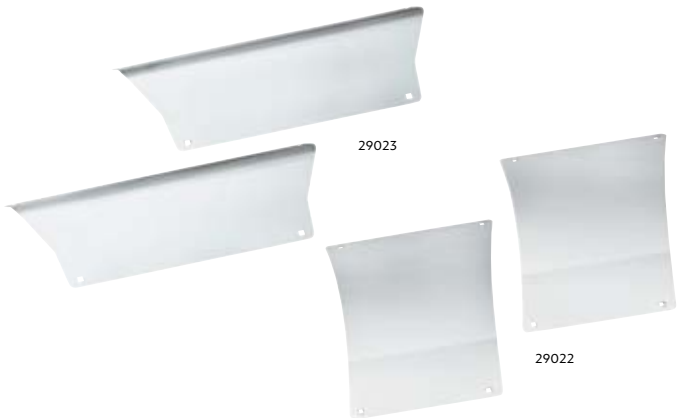

Stainless Steel Back Step Trim for Peterbilt 579

- Highly polished 430 stainless steel
- Attaches using supplied 3M two-sided tape
- Sold in pairs, please specify upper or lower step trim

29023 **Upper Back Step Trim** - 1 Pair / Card

29022 **Lower Back Step Trim** - 1 Pair / Box

**Stainless Steel Front Step Trim for Peterbilt 579**

- Highly polished 430 stainless steel
- Attaches using supplied 3M two-sided tape
- Sold in pairs

29024 1 Pair / Card**Stainless Steel Front Step Trims for Peterbilt 386**

- Highly polished 430 stainless steel
- Attaches using supplied 3M two-sided tape
- Sold in pairs

29020 1 Pair / Box**Stainless Steel Hood Emblem Stripe Accent for 2007+ Peterbilt 389**

- Highly polished stainless steel
- Emblem accents are mounted using existing emblem mounting studs, and supplied 3M two-sided tape
- Sold in pairs

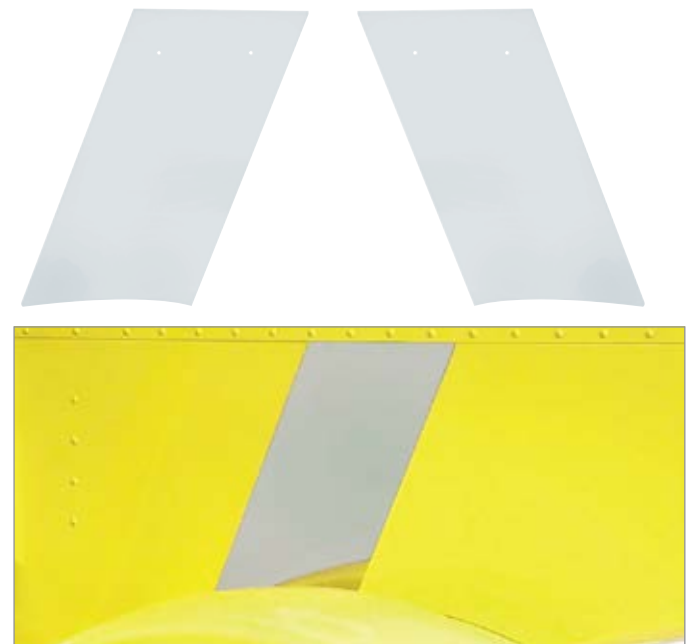
29028 1 Pair / Card**Stainless Steel Hood Emblem Stripe Accent for 2007+ Peterbilt 388**

- Highly polished stainless steel
- Emblem accents are mounted using existing emblem mounting studs, and supplied 3M two-sided tape
- Sold in pairs

29027 1 Pair / Card

PETERBILT

Door Handle Trim / License Plate Holders



Stainless Steel Door Handle Trim for Peterbilt 567/579

- Highly polished 430 stainless steel
- Attaches using supplied 3M two-sided tape
- Sold in pairs

29025 1 Pair / Card



Stainless Steel Single License Plate & Swing Plate for Peterbilt & Kenworth Models

- Highly polished 430 stainless steel
- Install to existing license plate location
- License plate frame and hardware included

29136 1 Pc. / Bulk

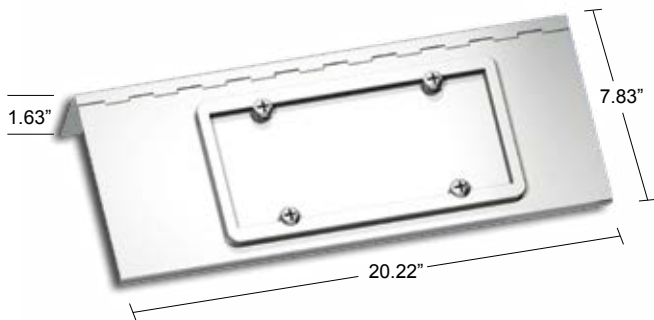

Stainless Steel Single License Plate & Swing Plate for 2007+ Peterbilt 388/389

- Highly polished 430 stainless steel
- Install to existing license plate location
- License plate frame and hardware included

29132 1 Pc. / Bulk

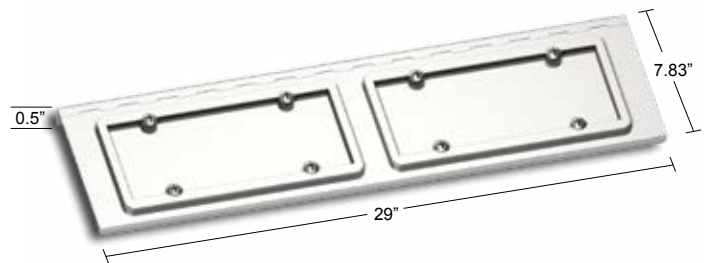

Stainless Steel Dual License Plate & Swing Plate for All Peterbilt Models

- Highly polished 430 stainless steel
- Install to existing license plate location
- License plate frame and hardware included

29131 1 Pc. / Bulk



Stainless Steel Bug Deflector for 2013+ Kenworth T680

- Highly polished 430 stainless steel
- Mounting holes pre-punched for easy installation
- Drilling required for mounting
- Installation hardware included

29122 1 Pc. / Box



Stainless Steel Bug Deflector for 2011+ Kenworth T700

- Highly polished 430 stainless steel
- Mounting holes pre-punched for easy installation
- Drilling required for mounting
- Installation hardware included

29006 1 Pc. / Box



Stainless Steel Bug Deflector for Kenworth T660

- Highly polished 430 stainless steel
- Mounting holes pre-punched for easy installation
- Drilling required for mounting
- Installation hardware included

29005 1 Pc. / Box

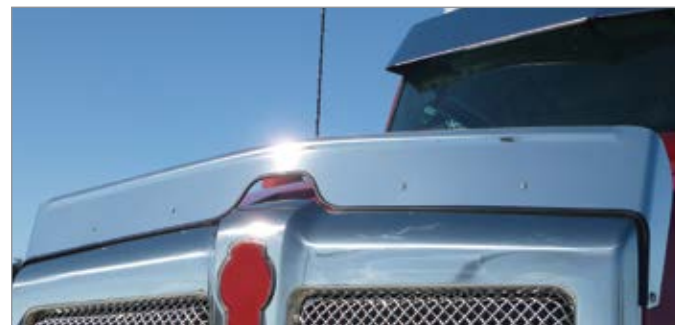

Stainless Steel Bug Deflector for 2014+ Kenworth T880

- Highly polished 430 stainless steel
- Mounting holes pre-punched for easy installation
- Drilling required for mounting
- Installation hardware included

29109 1 Pc. / Box



Stainless Steel Bug Deflector for Kenworth W900B

- Highly polished 430 stainless steel
- Mounting holes pre-punched for easy installation
- Drilling required for mounting
- Installation hardware included

29010 1 Pc. / Box



Stainless Steel Bug Deflector for Kenworth W900L

- Highly polished 430 stainless steel
- Mounting holes pre-punched for easy installation
- Drilling required for mounting
- Installation hardware included

29011 1 Pc. / Box



**Stainless Steel Bug Deflector for 1993-06
Kenworth T800 Wide Hood & C500**

- Highly polished 430 stainless steel
- Mounting holes pre-punched for easy installation
- Drilling required for mounting
- Installation hardware included

29009 1 Pc. / Box



Stainless Steel Bug Deflector for Kenworth T600

- Highly polished 430 stainless steel
- Mounting holes pre-punched for easy installation
- Drilling required for mounting
- Installation hardware included

29004 1 Pc. / Box



Stainless Steel 10" Drop Style Sunvisor for 2007+ Kenworth Aerocab with Curved Glass & B-Cab

- Highly polished 430 stainless steel
- Drilling required for mounting
- Exposed-rivet style for that rugged look
- Replaces OEM "one piece visor"

29102 1 Pc. / Box



Stainless Steel 13 1/2" Curved Windshield Drop Style Sunvisor for 1989 and newer Kenworth W900L, W900B & T800

- Highly polished 430 stainless steel
- Complete kit with stainless steel bracket

28013 1 Pc. / Box



Stainless Steel Curved Windshield Drop Visor for Kenworth W900

- Highly polished stainless steel
- Mounting holes pre-punched for easy installation

28002 1 Pc. / Box



Stainless Steel Fender Guards for 2007+ Kenworth T800 Curved Glass Models

- Highly polished 430 stainless steel
- Drilling required, hardware included
- Sold in pairs

29043 1 Pair / Card

KENWORTH
Fender Guards



Stainless Steel Under Headlight Fender Guard for 1989-2011 Kenworth W900L

- Highly polished 430 stainless steel
- Mounts on the fender below the headlight
- Pre-punched rivet holes, drilling required for mounting

29115 1 Pair / Card



Stainless Steel Fender Guard for 2014 Kenworth T880

- Highly polished 430 stainless steel
- Mounts on the fender below the headlight
- Die stamped to match the curve of the fender section with pre-punched rivet holes, drilling required for mounting

29105 1 Pair / Box



Stainless Steel Fender Guards for Kenworth T800 Aerocab

- Highly polished 430 stainless steel
- Drilling required, installation hardware included
- Sold in pairs

29044 1 Pair / Card



Stainless Steel Above Headlight Fender Guards for Kenworth T600

- Highly polished 430 stainless steel
- Drilling required, installation hardware included
- Sold in pairs

29041 1 Pair / Card



Stainless Steel Below Headlight Fender Guards for Kenworth T600

- Highly polished 430 stainless steel
- Drilling required, installation hardware included
- Sold in pairs

29042 1 Pair / Card



Stainless Steel Front Fender Guards for 2002 Kenworth W900

- Highly polished stainless steel

20583 1 Pair / Bulk

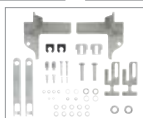
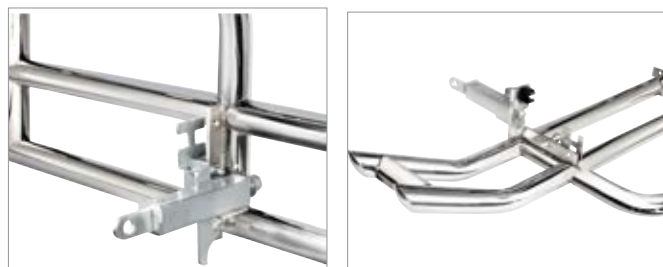

Grille Guard Mounting Bracket Set for 2013-2021 Kenworth T680

- Durable steel construction with zinc plated hardware. Easy installation on OEM tow hook receivers
- Bracket set designed for grille guard to tilt forward for easy access to bumper, grille and lights, and clears hood when opening
- Instruction sheet included. For use with Grille Guard #80000
- Note: Installation requires access to tow hook receivers on frame through original bumper. If using aftermarket bumper, be sure that the tow hook receivers are accessible
- Installation requires use of vehicles original tow hook pins
- May not be compatible with trucks equipped with electronic sensors, radar, VORAD systems

80002 1 Pair / Box



Stainless Steel Door Window Shade for All Kenworth Trucks with Daylight Doors & Passenger Side Single Convex Mirror

- Highly polished 430 stainless steel
- Laser cut to match the curvature of the door window frame
- Features clearance notch for RH side's over-the-door convex mirror bracket

29112 1 Pair / Box

KENWORTH

Door Trim / Lower Hood Panel / Tow Hole Cover



Stainless Steel Door Window Accent for Peterbilt 387, 2011+ Peterbilt 587 & Kenworth T700

- Highly polished 430 stainless steel
- Attaches using supplied 3M two-sided tape
- Sold in pairs

29046 1 Pair / Card



Stainless Steel Daylight Door Trim for 2008+ Kenworth Models with Daylight Door

- Highly polished 430 stainless steel
- Laser cut to match the curvature of the door window frame
- Precision punched round extrusions for door rivet clearance
- Attach to door via included double sided tape

29108 1 Set / Bulk



Stainless Steel Plain Lower Hood Panel for 1989+ Kenworth W900L

- Highly polished 430 stainless steel
- Pre-punched rivet and emblem mounting holes
- Emblem not included
- Drilling required for mounting

29119 2 Pc. / Box



Stainless Steel Bolt-less Tow Hole Cover for All Kenworth Models with 2" Receiver

- Highly polished 430 stainless steel
- Heavy duty spring loaded mounting design, keeps cover tightly secured to any 2" tow receiver without any addition hardware

29103 1 Set / Bulk



Stainless Steel Plain Vent Door Cover for Freightliner

- Highly polished stainless steel
- 10 1/2" x 5"
- Sold in pairs

20568 2 Pcs. / Bulk



Stainless Steel Plain Vent Door Cover for Freightliner

- Highly polished stainless steel
- 8 3/4" x 4 1/2"
- Sold in pairs

20570 2 Pcs. / Bulk



Stainless Steel Vent Door Cover and Dimpled Trim Set for Kenworth

- Highly polished stainless steel
- Fits Kenworth without louver
- Set includes 2 vent door covers and 2 dimpled trims

20563 4 Pcs. / Card



Stainless Steel Dimpled Cab Vent Trim for Kenworth

- Highly polished stainless steel
- Attaches using supplied two-sided tape
- Sold in pairs

20567 2 Pcs. / Card



Stainless Steel Bunk Vent Cover Kit for Kenworth T700

- Highly polished 430 stainless steel
- The bunk vent cover kit consists of the vent cover and outer trim ring
- Attaches using supplied 3M two-sided tape
- Sold as a 2pc-piece kit

29045 1 Set / Card

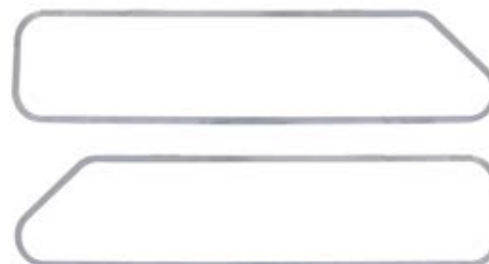

Stainless Steel Upper Sleeper Window Trim for Kenworth

- Highly polished stainless steel
- Please specify driver side or passenger side

21721B **Driver Side** - 1 Pc. / Bulk

21722B **Passenger Side** - 1 Pc. / Bulk

KENWORTH

Lower Sleeper Window Trim / Emblem Accents / Grille Bars



Stainless Steel 41" Center Grille Bar for Kenworth

- Highly polished stainless steel
- Mounting hardware included

21162 1 Pc. / Box



Stainless Steel 39 1/2" Grille Bar for Kenworth

- Highly polished stainless steel
- Mounting hardware included

21161 1 Pc. / Box



Stainless Steel 33 1/2" Grille Bar for Peterbilt & Kenworth

- Highly polished stainless steel
- OEM style design, bolt mount included

21160 1 Pc. / Box



Stainless 8" Chopped Window Trim for Kenworth T680/T880 Trucks

- Fits 2013 and newer Kenworth T680 & T880 trucks
- Easy to install pressure sensitive adhesive mounting
- Mirror like 304 premium grade stainless steel
- Includes 1 left and 1 right side trim
- Does not have cutout for passenger side upper mirror

29057 1 Pair / Skin Pack

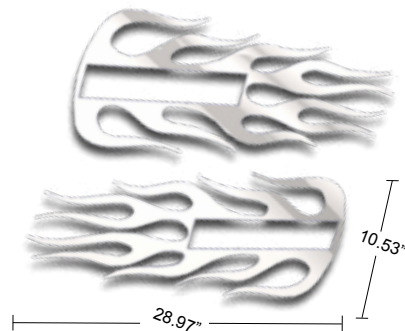

Stainless Steel Hood Emblem Accent Flame for All Kenworth Models

- Highly polished 430 stainless steel
- Easy installation with included double sided tape

29118 1 Pair / Box

**Stainless Steel Emblem Accent for Kenworth**

- Highly polished stainless steel
- Mounting hardware included

10927 1 Pair / Skin Pack

**Stainless Steel Lower Sleeper Window Trim for Kenworth**

- Highly polished stainless steel

21720 1 Pc. / Skin Pack

**Stainless Steel Air Intake Cover for Kenworth T600/T800**

- Highly polished 430 stainless steel
- Installation hardware included

29040 1 Pc. / Card

**Stainless Steel Air Intake Shroud for 2008+ Kenworth T800 with Split Fender Metton Hood**

- Highly polished 430 stainless steel
- Mounts on the side of the hood, protects the air intake tubing from road debris
- Drilling required for mounting

29110 1 Pair / Box

**Stainless Steel Fender Light Trim for Kenworth T660**

- Highly polished 430 stainless steel
- Attaches using supplied 3M two-sided tape
- Sold in pairs

29056 1 Pair / Card

KENWORTH

Logo Trim / Air Intake Grille / Front Upper Step Kick Plate



Stainless Steel Air Intake Logo Trim for 2008+ Kenworth T660/T370

- Highly polished 430 stainless steel
- Attaches using supplied hardware and 3M two-sided tape

29051 1 Pc. / Card

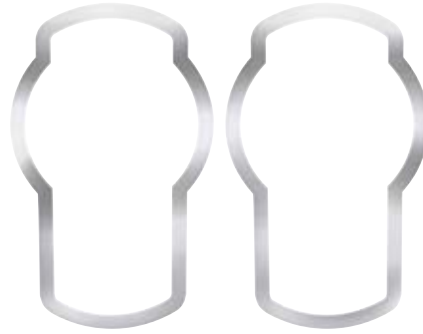

Stainless Steel Hood Logo Trim for 2007+ Kenworth T660/T370

- Highly polished 430 stainless steel
- Attaches using supplied 3M two-sided tape
- Sold in pairs

29052 1 Pair / Card

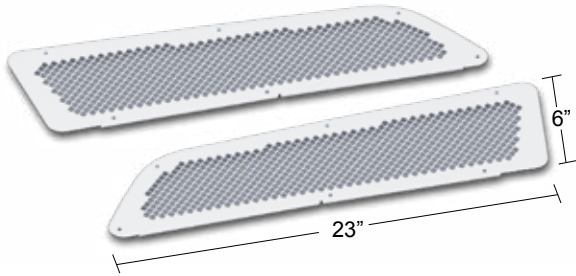

Stainless Steel Air Intake Grille for 2014+ Kenworth T880

- Highly polished 430 stainless steel
- Mesh style design
- Installs to existing intake vent pocket

29116 1 Pair / Box



Stainless Steel Front Upper Step Kick Plate for Kenworth T700

- Highly polished 430 stainless steel
- Hardware included
- Sold in pairs

29048 1 Pair / Box



Stainless Steel Front Lower Step Kick Plate for Kenworth T700

- Highly polished 430 stainless steel
- Hardware included
- Sold in pairs

29047 1 Pair / Box



Stainless Steel Front Upper Step Kick Plate for 2010+ Kenworth T660 (EPA)

- Highly polished 430 stainless steel
- Attaches using supplied hardware to the upper step
- Sold in pairs

29054 1 Pair / Box



Stainless Steel Front Upper Step Kick Plate for 2007-09 Kenworth T660

- Highly polished 430 stainless steel
- Attaches using supplied hardware to the upper step
- Sold in pairs

29053 1 Pair / Box



Stainless Steel Back Upper Step Kick Plate for 2007+ Kenworth T660/T680/T700

- Highly polished 430 stainless steel
- Attaches using supplied hardware and 3M two-sided tape
- Sold in pairs

29050 1 Pair / Box

KENWORTH

Lower Step Kick Plates / License Plate & Swing Plates



Stainless Steel Back Lower Step Kick Plate for 2007+ Kenworth T660/T680/T700

- Highly polished 430 stainless steel
- Attaches using supplied hardware and 3M two-sided tape
- Sold in pairs

29049 1 Pair / Box

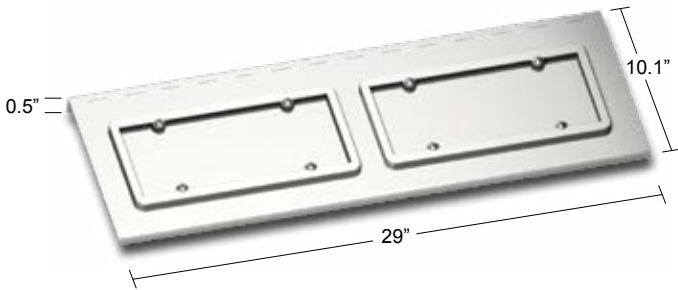

Dual License Plate & Swing Plate Hinged Texas Style Design for 1993-2011 Kenworth W900

- Highly polished 430 stainless steel
- Attaches using supplied hardware

29120 1 Pc. / Box



Stainless Steel Front Lower Step Kick Plate for 2007+ Kenworth T660

- Highly polished 430 stainless steel
- Attaches using supplied hardware, sold in pairs

29055 1 Pair / Box



Stainless Steel Single License Plate & Swing Plate for All Kenworth Models

- Highly polished 430 stainless steel
- Install to existing license plate location
- License plate frame and hardware included

29113 1 Pc. / Bulk

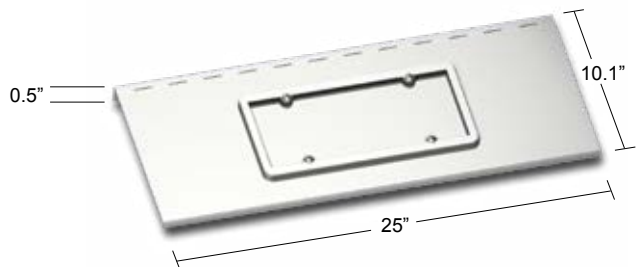

Single License Plate & Swing Plate Hinged Texas Style Design for 1993-2011 Kenworth W900

- Highly polished 430 stainless steel
- Attaches using supplied hardware

29121 1 Pc. / Box



Stainless Steel Bug Grille Deflector Kit for 2003+ Volvo VN

- Highly polished 430 stainless steel
- Drilling of mounting holes through hood required
- Four piece stainless steel bug deflector and grille kit surround the grille

29013 1 Pc. / Box



Stainless Steel Bug Deflector Kit for Volvo Day Cab 420/610/660/770

- Highly polished 430 stainless steel
- Drilling of mounting holes through hood required, installation hardware included
- Mounts behind grille bezel

29014 1 Pc. / Box



Stainless Steel Back Bug Deflector for 2003+ Volvo VN

- Highly polished 430 stainless steel
- Drilling of mounting holes through hood required
- Installation hardware included

29012 1 Pc. / Box



Stainless Steel Sunvisor Extension Strip for Volvo 660/670/770/780/880

- Highly polished 430 stainless steel
- Provides additional 3" of visor coverage
- Easy installation, double sided tape and mounting screws included

29141 1 Pc. / Box

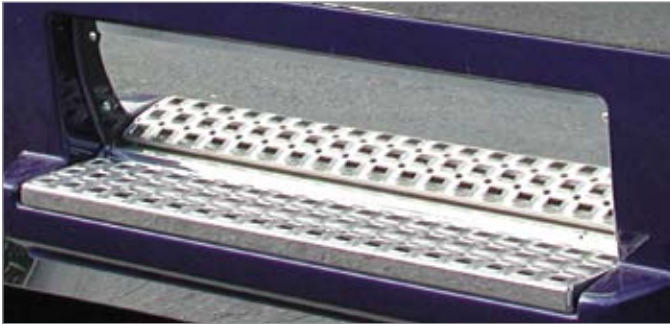

Stainless Steel Step Front Lower Step Kick Plate for 2003+ Volvo VN

- Highly polished heavy gauge 430 stainless steel
- Attaches using supplied hardware and 3M Two-sided tape
- Sold in pairs

29062 1 Pair / Card

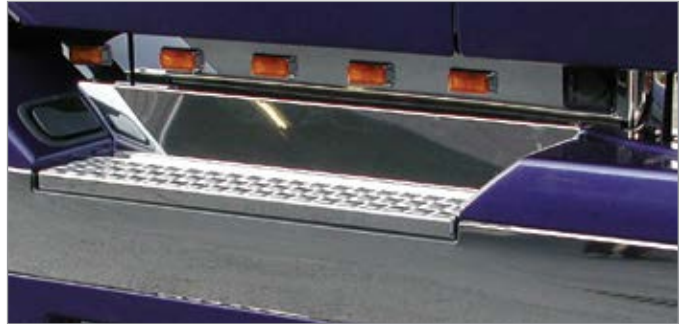
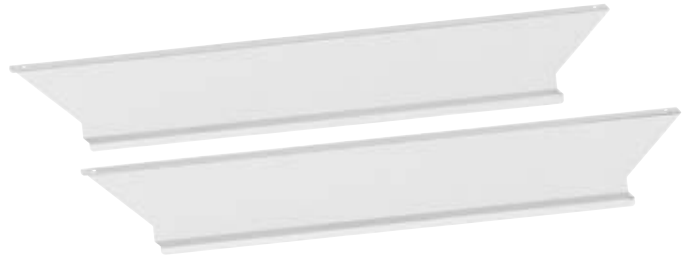

Stainless Steel Front Upper Fairing Kick Plate for 2003+ Volvo VN

- Highly polished 430 stainless steel
- Attaches using supplied hardware and 3M Two-sided tape
- Sold in pairs

29064 1 Pair / Box



Stainless Steel Back Lower Step Kick Plate for 2003+ Volvo VN

- Highly polished heavy gauge 430 stainless steel
- Attaches using supplied hardware and 3M Two-sided tape
- Sold in pairs

29063 1 Pair / Box



Stainless Steel Back Lower Step Kick Plate for 2006+ Volvo VNL

- Highly polished 430 stainless steel
- Attaches using supplied hardware and 3M Two-sided tape
- Sold in pairs

29061 1 Pair / Card



Stainless Steel Front Lower Step Kick Plate for 2006+ Volvo VN

- Highly polished 430 stainless steel
- Attaches using supplied hardware and 3M Two-sided tape
- Sold in pairs

29060 1 Pair / Card



Stainless Steel Urea Tank Filler Cover Panel for 2011+ Volvo EPA

- Highly polished 430 stainless steel
- Drilling of mounting holes through hood required
- Installation hardware included, sold in pairs

29067 1 Pair / Box

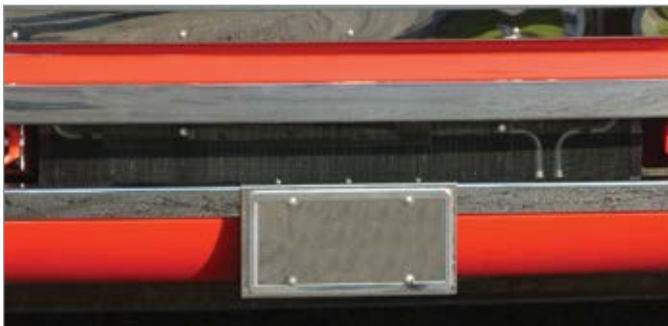
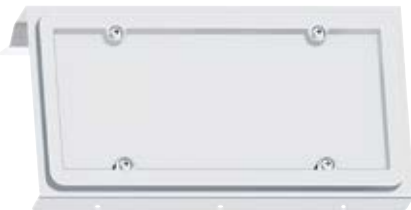

Stainless Steel License Plate Holder for 2003+ Volvo VN

- Highly polished 430 stainless steel
- License plate bezels included
- Attaches using supplied hardware

29065 1 Pc. / Box



Stainless Steel License Plate Holder for 2003+ Volvo VN

- Highly polished 430 stainless steel
- License plate bezels included
- Attaches using supplied hardware

29066 1 Pc. / Box



Stainless Steel Hood Trim for 2003+ Volvo VN/VL

- Highly polished 430 stainless steel
- Attaches using supplied hardware and 3M two-sided tape
- Sold individually, please specify LH or RH side

41667B LH - 1 Pc. / Box

41668B RH - 1 Pc. / Box



Stainless Steel Fender Guard for 2003+ Volvo VN/VNL

- Highly polished 304 stainless steel
- Double sided tape mount included
- Sold in pairs

29068 1 Pair / Box



Stainless Steel Door Handle Trim for Volvo VN/VT/VHD

- Highly polished 430 stainless steel
- Protects key cylinder housing from key scratches
- Easy installation with included double sided tape

29139 1 Pair / Bulk



Grille Guard Mounting Bracket Set for 2004-2017 Volvo VNL

- Durable steel construction with zinc plated hardware. Easy installation on OEM tow hook receivers
- Bracket set designed for grille guard to tilt forward for easy access to bumper, grille and lights, and clears hood when opening
- Instruction sheet included. For use with Grille Guard #80000
- Note: Installation requires access to tow hook receivers on frame through original bumper. If using aftermarket bumper, be sure that the tow hook receivers are accessible
- Installation requires use of vehicles original tow hook pins
- May not be compatible with trucks equipped with electronic sensors, radar, VORAD systems

80004 Set / Box

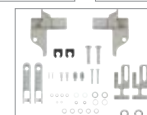



Stainless Steel Bug Deflector for 2007+ Mack CXP613/GU813

- Highly polished 430 stainless steel
- Precision cut to match the curvature of the hood and grille
- Mounting holes pre-punched for easy installation
- Drilling required, installation hardware included

29123 1 Pc. / Box

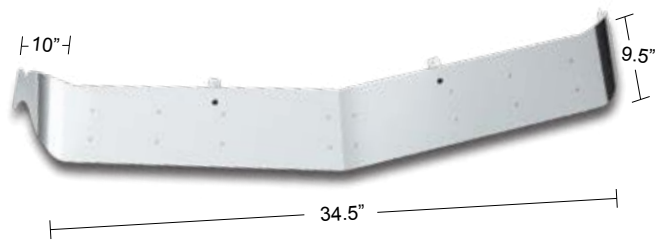

Stainless Steel OEM Style Sunvisor for Mack CH/CX/Granite/Vision without Roof Fairing

- Highly polished 430 stainless steel
- Precision punched mounting holes for easy replacement over original visor

29125 1 Pc. / Box



Stainless Steel Upper Scuff Panel with Logo for Mack CH/CL

- Highly polished 430 stainless steel
- Laser cut "Mack" logo
- Pre-punched rivet mounting holes
- Easy installation with included double sided tape

29124 1 Pair / Box

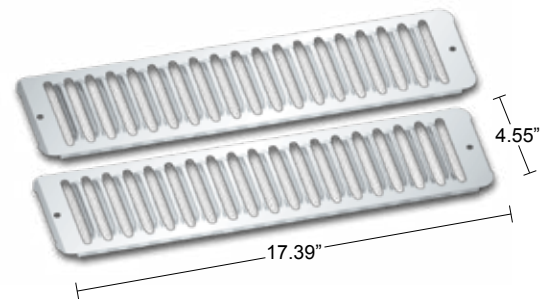

Stainless Steel Hood Air Intake Trim for 1988+ Mack CH

- Highly polished 430 stainless steel
- Mesh style design
- Installs to existing intake vent pocket

29126 1 Pair / Box

INTERNATIONAL

Bug Deflectors / Fender Guards



Stainless Steel Bug Deflector for International 9900 Series/59001 SFA

- Highly polished 430 stainless steel
- Drilling of mounting holes through hood required
- Installation hardware included
- Mounts behind grille bezel

29016 1 Pc. / Box



Stainless Steel Bug Deflector for International ProStar

- Highly polished 430 stainless steel
- Drilling of mounting holes through hood required
- Installation hardware included
- Mounts behind grille bezel

29015 1 Pc. / Box



Stainless Steel Bug Deflector for 2002+ International 4000 Series

- Highly polished 430 stainless steel
- Drilling of mounting holes through hood required
- Installation hardware included
- Mounts behind grille bezel

29017 1 Pc. / Box



Stainless Steel Fender Guards for International ProStar

- Highly polished 430 stainless steel
- Attaches using supplied 3M two-sided tap
- Sold in pairs

29070 1 Pair / Box

Vent Covers / Grille Bar / Fuel Filler Insert Trim / Backup Light Bracket / Grille Guard Mounting Set



Stainless Steel Louvered Vent Covers for International ProStar/LoneStar

- Highly polished 430 stainless steel
- Attaches using supplied 3M two-sided tap
- Sold in pairs

29071 1 Pair / Card



Stainless Steel 26 1/2" Grille Bar for International

- Highly polished stainless steel
- Mounting hardware included

21157 1 Pc. / Box



Stainless Steel Fuel Filler Insert Trim for International ProStar

- Highly polished 430 stainless steel
- Attaches using supplied 3M two-sided tap
- Sold in pairs

29073 1 Pair / Card

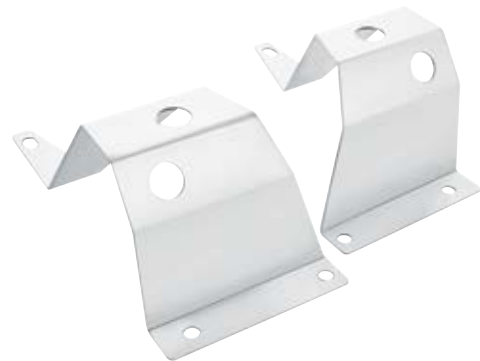

Stainless Steel Backup Light Bracket for International

- Stainless steel backup light bracket for International trucks
- Hardware not included
- 430 Stainless Steel, sold in pairs

29072 1 Pair / Box

Grille Guard Mounting Bracket Set for International Prostar (2006-2017 & LT (2018-2022))

- Durable steel construction with zinc plated hardware. Easy installation on OEM tow hook receivers
- Bracket set designed for grille guard to tilt forward for easy access to bumper, grille and lights, and clears hood when opening
- Instruction sheet included. For use with Grille Guard #80000
- Note: Installation requires access to tow hook receivers on frame through original bumper. If using aftermarket bumper, be sure that the tow hook receivers are accessible
- Installation requires use of vehicles original tow hook pins
- May not be compatible with trucks equipped with electronic sensors, radar, VORAD systems

80004 Set / Box



WESTERN STAR

Bug Deflectors / Sunvisor / Fender Guards



Stainless Steel Bug Deflector for 2000 - 2018 Western Star 4964 SX with High Visibility Hood

- Highly polished 430 stainless steel
- Precision cut to match the curvature of the hood and grille
- Mounting holes pre-punched for easy installation
- Drilling required for mounting
- Installation hardware included

29143 1 Pc. / Box



Stainless Steel Bug Deflector for 2000+ Western Star 4964/FX/FA/EX/SX

- Highly polished 430 stainless steel
- Precision cut to match the curvature of the hood and grille
- Mounting holes pre-punched for easy installation
- Drilling required for mounting
- Installation hardware included

29142 1 Pc. / Box

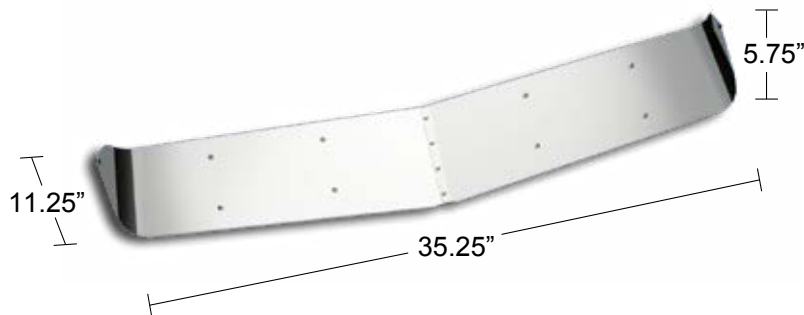

Stainless Steel Plain Style Sunvisor for 2002 - 2018 Western Star Constellation/4700 with OE Visor

- Highly polished 430 stainless steel
- Mounting holes pre-punched for easy installation
- Exposed-rivet style for that rugged look

29144 1 Pc. / Box



Stainless Steel Fender Guard with Curved End & Headlight Accent for 1998 - 2018 Western Star Constellation

- Highly polished 430 stainless steel
- Mounts on the fender below the headlight
- Die stamped to match the curve of the fender section
- 1 pc. design with headlight housing surround bezel
- Drilling required for mounting

29145 1 Pair / Box



Stainless Steel Fender Guard for 2007+ Western Star 4900/FA/EPA

- Highly polished 430 stainless steel
- Mounts on the fender below the headlight
- Die stamped to match the curve of the fender section
- 1 pc. with headlight housing surround bezel
- Drilling required for mounting

29146 1 Pair / Box



304 Stainless Steel Grille Guard (Mounting Bracket Set Sold Separately)

- Highly polished 304 premium grade stainless steel for durability and shine
- Heavy duty 3" tubular welded construction for superior protection of the bumper and grille
- 14 gauge polished stainless steel
- Approximate size: 90-1/2" X 25-1/2" X 11-3/4"
- Pallet freight shipment only
- Bracket sets sold separately (item# 80001, 80003, 80004, 80005).
- May not be compatible with trucks equipped with electronic sensors, radar, VORAD systems

80000 1 Pc. / Bulk



Grille Guard Mounting Bracket Set for 2008-2017 Freightliner Cascadia

- Durable steel construction with zinc plated hardware. Easy installation on OEM tow hook receivers
- Bracket set designed for grille guard to tilt forward for easy access to bumper, grille and lights, and clears hood when opening
- Instruction sheet included. For use with Grille Guard #80000
- Note: Installation requires access to tow hook receivers on frame through original bumper. If using aftermarket bumper, be sure that the tow hook receivers are accessible
- Guard will obstruct standard bumper mounted license plate, relocation is highly recommended
- Not compatible with trucks equipped with Active Brake Assist system

80000 1 Set / Box

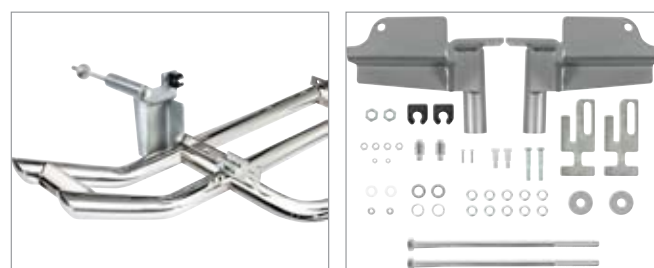

UNIVERSAL

License Plate Holders / Cross Cutout / Small Gauge Cover



Stainless Steel 2 License Plate Holder

- Highly polished stainless steel

21539 1 Pc. / Bulk



Stainless Steel 3 License Plate Holder

- Highly polished stainless steel

21540 1 Pc. / Box



Stainless Steel 14" x 8 1/4" 1 License Plate Holder

- Highly polished stainless steel

21551 1 Pc. / Bulk



Stainless Steel 14 1/2" x 8 1/2" 1 License Plate Holder w/ Hinge

- Highly polished stainless steel

21552 1 Pc. / Bulk



Stainless Steel 7 1/2" x 18 1/4" 1 License Plate Holder

- Highly polished stainless steel
- 7 1/2" width x 18 1/4" height
- Does not include lights, or frame

21538 1 Pc. / Bulk



Stainless Steel 4"x5" 1 Permit Sticker Plate With Adhesive

- Highly polished 304 premium grade stainless steel for durability and shine
- High quality Universal permit panel
- Adhesive application for easy installation
- Available in retail packaging

21904 1 Pc. / Bulk



79 1/2" Stainless Steel Bumper Light Bracket with Six 14 LED 12" Light Bars - Amber LED/Amber Lens

- Highly polished stainless steel
- 79 1/2" x 1 3/8"
- 14 Amber LEDs with amber lens item # (38946B x 6)
- Stainless steel light bracket item # (20678)

20671 1 Pc. / Bulk



79 1/2" Stainless Steel Bumper Light Bracket with Six 14 LED 12" Light Bars - Amber LED/Chrome Lens

- Highly polished stainless steel
- 79 1/2" x 1 3/8"
- 14 Amber LEDs with chrome lens item # (39644B x 6)
- Stainless steel light bracket item # (20678)

20676 1 Pc. / Bulk



94" Stainless Steel Bumper Light Bracket with Seven 14 LED 12" Light Bars - Amber LED/Amber Lens

- Highly polished stainless steel
- 94" x 1 7/8"
- 14 Amber LEDs with amber lens item # (38946B x 6)
- Stainless steel light bracket item # (20870)

20873 1 Pc. / Bulk



94" Stainless Steel Bumper Light Bracket with Seven 14 LED 12" Light Bars - Amber LED/Clear Lens

- Highly polished stainless steel
- 94" x 1 7/8"
- 14 Amber LEDs with clear lens item # (38948B x 6)
- Stainless steel light bracket item # (20870)

20875 1 Pc. / Bulk

UNIVERSAL

94" Bumper Light Brackets with LED lighting



94" Stainless Steel Bumper Light Bracket with Seven 14 LED 12" Light Bars - Amber LED/Chrome Lens

- Highly polished stainless steel
- 94" x 1 7/8"
- 14 Amber LEDs with chrome lens item # (39644B x 6), stainless steel light bracket item # (20870)

20879 1 Pc. / Bulk



94" Stainless Steel Bumper Light Bracket with Seven 14 LED 12" Light Bars - Red LED/Red Lens

- Highly polished stainless steel
- 94" x 1 7/8"
- 14 Red LEDs with red lens item # (38947B x 6), stainless steel light bracket item # (20870)

20874 1 Pc. / Bulk



94" Stainless Steel Bumper Light Bracket with Seven 14 LED 12" Light Bars - Red LED/Clear Lens

- Highly polished stainless steel
- 94" x 1 7/8"
- 14 Red LEDs with clear lens item # (38949B x 6), stainless steel light bracket item # (20870)

20877 1 Pc. / Bulk



94" Stainless Steel Light Bracket with Seven 14 LED 12" Light Bars - Red LED/Chrome Lens

- Highly polished stainless steel
- 94" x 1 7/8"
- 14 Red LEDs with chrome lens item # (39645B x 6), stainless steel light bracket item # (20870)

20880 1 Pc. / Bulk



94" Stainless Steel Bumper Light Bracket with Seven 14 LED 12" Light Bars - Blue LED/Clear Lens

- Highly polished stainless steel
- 79 1/2" x 1 3/8"
- 14 Blue LEDs with clear lens item # (39483B x 6), stainless steel light bracket item # (20870)

20876 1 Pc. / Bulk



**94" Stainless Steel Light Bracket
with Seven 14 LED 12" Light Bars - White LED/Clear Lens**

- Highly polished stainless steel
- 94" x 1 7/8"
- 14 White LEDs with clear lens item # (39485B x 6), stainless steel light bracket item # (20870)

20878 1 Pc. / Bulk



**94" Stainless Steel Bumper Light Bracket
with Seven 19 LED 12" Reflector Light Bars - Amber LED/Amber Lens**

- Highly polished stainless steel
- 94" x 1 7/8"
- 19 Amber LEDs with amber lens item # (39773B x 6), stainless steel light bracket item # (20870)

20881 1 Pc. / Bulk



**94" Stainless Steel Light Bracket
with Seven 19 LED 12" Reflector Light Bars - Red LED/Red Lens**

- Highly polished stainless steel
- 94" x 1 7/8"
- 19 Red LEDs with red lens item # (39774B x 6), stainless steel light bracket item # (20870)

20882 1 Pc. / Bulk



**94" Stainless Steel Bumper Light Bracket
with Seven 19 LED 12" Reflector Light Bars - Amber LED/Clear Lens**

- Highly polished stainless steel
- 94" x 1 7/8"
- 19 Amber LEDs with clear lens item # (39775B x 6), stainless steel light bracket item # (20870)

20883 1 Pc. / Bulk



**94" Stainless Steel Light Bracket
with Seven 19 LED 12" Reflector Light Bars - Red LED/Clear Lens**

- Highly polished stainless steel
- 94" x 1 7/8"
- 19 Red LEDs with clear lens item # (39776B x 6), stainless steel light bracket item # (20870)

20884 1 Pc. / Bulk

Terms & Conditions / Ordering Guidelines

New Accounts

Initial buy-in amount and/or quantity is to be determined by United Pacific Industries, UPI hereafter. All initial orders must be prepaid in advance by Cashier's Check or VISA/MC/AMX. All new/potential accounts must complete a UPI "New Dealer Info/Credit Form" and follow the Dealer Qualification Instructions. Upon completion of the credit application, approved accounts will be assigned payment terms of NET 30 Days (from invoice date). Accounts denied a credit line will be required to prepay in advance by Cashier's Check, ACH or Bank wire or VISA/MC/AMX.

Payment Terms

Term Accounts: Accounts with NET 30 Days terms are required to submit payment within the 30 days from the date of invoice. Acceptable forms of payment include checks, ACH (Automated Clearing House), or wire transfer.

A service charge of 1.5% per month will be imposed on invoices not paid within the 30-day term. Delinquent accounts will be required to pay Cash-In-Advance (CIA). Checks will be accepted but orders will not be released until the check is cleared by the bank. Past due invoices will delay current orders. Please check with UPI on your account status when placing an order.

Credit Cards

Accounts denied credit terms may be given the option to pay by Visa, MasterCard or American Express. The credit card will be charged upon shipment. A 3% service fee will be added to the invoice. Credit card payments will not be accepted once an order has been shipped. UPI does not accept Discover card.

COD

There is no COD payment offered.

Returned Checks

A \$30.00 NSF (Non-Sufficient Fund) fee will be assessed on each incidence a check is returned to UPI.

Ordering Guidelines

Placing Orders

New orders and PO's may be placed by any of the following methods:

- Dealer Portal
- Fax: (888) 986-5988
- E-mail: sales@upauto.com
- Telephone: In order to minimize errors, dealers are encouraged to submit their orders by fax or mail. Telephone orders are generally not preferred as to minimize errors. Utilize one of the methods above for placing orders.

Changes to Orders

Once orders are released for picking changes are no longer possible. Dealers would have to submit a new PO for any additional items needed.

Canceling Orders

Cancellation of Stock orders must be submitted via fax or email within 24 hours of the order date. If the Stock order has already shipped it will be the dealer's responsibility to return the order at the dealer's own expense. A restocking fee may apply, please see "Return" policy for further detail. Drop Ship orders cannot be canceled due to the priority processing

Backorders

Dealers have the option of having their backorders shipped or canceled. UPI will notify dealer as to availability of backorders and will be able to ship any backorder items dealer still needs as part of their next stock order. UPI reserves the right to cancel backorders that are 2 month or older from invoice date.

Minimum Order

A minimum order of \$50.00 is required. Orders below \$50.00 will be assessed a minimum order fee of \$10.00.

Packaging

A 10% service charge will be added to orders with special packaging or UPC barcoding requirements.

Lead Times

Standard lead time for all United Pacific Stock orders is 5 business days from the receipt of the purchase order. Larger Stock orders may require a lead time of up to 7 business days. Drop Ship orders generally ship in 2 business days or less. Transit time of 3-5 business days must be considered when placing orders. UPI cannot be responsible for delays in shipment after an order leaves our warehouse. UPI will work to resolve delays with freight forwarding firms, however, delays do arise from time to time due to weather and unforeseen circumstances beyond UPI's control. Express orders are exempt; please view Freight/Shipping Policy for further detail.

Order Confirmation

United Pacific will acknowledge receipt of orders by email or EDI within 1 business day of receiving the PO. If confirmation is not received, please contact UPI to ensure your order was received.

Freight / Shipping Policy / Claims

Prepaid Freight

Stock orders between \$.01 and \$1,999.99 (US Lower 48 States and Canada), \$.01 and \$3,299.99 (Alaska and Hawaii), [all price net US\$], will be shipped FOB Long Beach, California. Stock orders of \$2,000.00 (US Lower 48 States and Canada), \$3,300.00 (Alaska and Hawaii), [all price net US\$], or more will be shipped Freight Prepaid Ground to a single location only. Exclusions on prepaid: 1) Grille Guard (item# 80000) will always ship FOB Long Beach. 2) Express NDA and 2-day orders, Special Net Pricing orders, and Special Quote Pricing orders ship FOB Long Beach. All drop shipment orders will be assessed a 5% processing fee. Drop shipment processing fee will be automatically added to the invoice without notice. No freight allowance or prepaid freight will be permitted for any drop shipment. All drop ship orders, regardless of order size, are FOB Long Beach, CA. A minimum order of \$50.00 is required. Orders below \$50.00 will be assessed a minimum order fee of \$10.00. United Pacific reserves the right to select the carrier of our choice. Freight paid orders do not include extra services such as liftgate fee.

Will Call Orders

Will Call orders can be picked up in 1-3 days after placing the order. Dealers will receive their scheduled pick-up time in the order confirmation. Dealers should always call ahead to confirm when order will be ready. Sorry no same-day pick-up allowed. Will Call hours are 8:30AM - 4:00PM PST.

Shipping Policy

International Shipments

Shipments to locations outside the continental United States will be shipped to the dealer's shipping agent or broker within the continental United States in accordance with the US freight policy. International dealers will be responsible for the duties and taxes of their respective country.

Shipping Policy / Claims

Express Orders

All express orders, such as Next Day, Second Day, 3 Day Service & Will Call, must be emailed, faxed, or sent via EDI. Order confirmation will be sent to the dealer for final approval. If confirmation is not received, please contact UPI to ensure your order was received. Dealers are required to sign off on express orders and send confirmation back to UPI. Cut off for express order is 10:00AM PST (Pacific Standard Time). Express orders received after 10:00AM PST will ship the next business day. Please contact UPI to confirm projected shipping date or will call time. Due to the high cost of express shipments, dealer may request UPI to notify them of freight charges. If dealer does not request confirmation, UPI will ship the express order.

Drop Shipments

All drop shipment orders will be assessed a 5% handling fee and will be automatically added to the invoice without notice. All drop shipment orders must be emailed, faxed, or sent via EDI. No freight allowance or prepaid freight will be permitted for any drop shipment; thus, all drop ship orders regardless of order size, are FOB Long Beach, CA

Claims

General Policy

All claims (Shortage, Mis-Shipped, Damage, Overage, Dealer Error & Billing Error) must be submitted to UPI within 3 business days of the receipt of shipment. Claims submitted beyond 3 business days of the receipt of shipment will be voided by UPI.

On all shipments, the person who signs and receives the shipment is responsible for noting on the Bill of Lading, in writing, whether any boxes arrived damaged or shorted. Failure to do so will void all claim rights between all parties. UPI will have no recourse against the trucking company if dealer does not note any damages or shortages on the Bill of Lading.

The dealer's receiving department must count and sign for the exact number of boxes received. Failure to follow the above instructions will void all claim rights between all parties.

Shortages / Mis-Ships / Damages

While UPI strives to fill every order with 100% accuracy, on occasion an item may get shipped in error or get damaged during shipping. In the event this occurs, please follow the process below. Note: This type of claim must be reported to UPI within three (3) business days of receiving the order.

1. Contact the United Pacific office to initiate the claim. To make it easy for you we have two acceptable methods for requesting the claim:
 - Email: returns@upauto.com
 - Fax : 888-986-5988

Note: To ensure you receive a timely credit, we cannot accept claim requests by phone.

2. You will be required to provide the following information:
 - Your business name
 - Contact name and telephone number (in case we have questions)
 - Date the order was received
 - A copy of the Packing List / Invoice noting the item number and quantity that was shipped in error or damaged during shipping.
 - Special instructions you have for us.
3. UPI will send a return label so you can ship the items back.
4. Once we receive the miss-shipped/damaged item(s) a credit will be issued to your account on the next billing cycle.
 - Shortages will be credit to the Dealers' account, unless dealer would like the shortages replaced.

Claims / Warranty

Overages

UPI strives to provide our dealers with the best dealer service and products, in turn we would greatly appreciate any help from dealer in notifying UPI of any shipping overages. Dealers will be offered the option of retaining the merchandise or returning the merchandise to UPI at UPI's expense. If the items are to be returned, an RMA number and return shipping label will be provided.

Dealer Errors

Any item or quantity ordered in error by the dealer may be returned by contacting UPI for a RMA number.

1. We have two acceptable methods for requesting the RMA:

- Email: returns@upauto.com
- Fax : 888-986-5988

Note: To ensure you receive a timely credit, we cannot accept claim requests by phone.

2. You will be required to provide the following information.

- Your business name
- Contact name and telephone number (in case we have questions)
- A list of the items number and quantity ordered in error
- Special instructions you have for us

3. UPI will review the request to ensure the products are within the return period.

4. Once we have validated the request, United Pacific will issue an RMA number to the dealer. In issuing the RMA approval, the following conditions will apply:

- Returned items are subject to a 20% re-stocking fee.
- Return shipping costs are the responsibility of the dealer.
- Items must not have any retail/price sticker on exterior package/box/card or they will be returned to the dealer at dealer's expense and no credit given.
- Items must be in good condition with original packaging intact, unblemished and in re-sellable condition, or they will be returned to the dealer at dealer's expense and no credit given.
- Allow up to 30 days for the credit to be issued from the time the returned items are received.

Billing Errors

Billing errors should be reported to UPI within 3 business days of invoice receipt. Dealers are asked to provide the invoice number, part number, and quantities in question. Once verified, UPI will issue a credit or an invoice for the difference in billing error.

Warranty

General Policy

UPI offers a NO HASSLE WARRANTY RETURN policy. Warranty claims can only be submitted through an authorized UPI Distributor. UPI warranty is not transferable and applies to the original installation and purchase only. UPI warranty varies by product and each item's warranty period is stated on UPI's product web page. In no event shall UPI be liable for incidental or consequential damages, nor shall UPI be liable for any claims or damages arising out of or connected with the UPI warranty which exceed the purchase price of the products.

There are no warranties, expressed or implied (including any warranty of merchantability or fitness) that extend beyond this warranty. The warranty does not apply to costs associated with the loss of use of the product, loss of time, inconvenience, commercial loss, incidental or consequential damages. The warranty does not apply to products which are damaged or made defective by faulty or incorrect installation. UPI reserves the right to alter the designs of products without assuming any obligation to modify previously manufactured products and will only replace warrantied products with redesigned products.

Warranty does not apply to merchandise that has been drilled, cut, welded, modified in any way or installed contrary to normal installation and usage. In addition, UPI cannot be held liable for damages caused by road hazards, accidents, misuse, neglect, water intrusion, abuse or corrosive environments including acid washes and highway snow/ice chemicals which can cause discoloration and corrosion in aluminum, chrome, stainless steel and light products. UPI reserves the right to credit returned merchandise at the initial purchase price or at the current selling price, which price ever is lower.

Aluminum / Chrome / Stainless Steel Products

Aluminum, chrome, and stainless steel products carry either a limited 6 month warranty, or a limited 1 year warranty (from invoice date) against defects in material or workmanship. Check the product page on our website for specific warranty period.

All Grill Guards (Item # 80000): A) Stainless Steel Materials and factory workmanship of the product itself carry a Limited Lifetime warranty. B) The Stainless steel polish and finish has a 12 month warranty. C) This warranty is provided only to the original purchaser/consumer, and on the original installation. Warranty is not transferable. Product failure or breakage due to accident/wreck or improper installation is not covered.

All mounting kits (Item # 80001, 80002, 80003, 80004, 80005): A) Steel Materials and factory workmanship on the sub-assembly bracket are Lifetime warranty. B) The painted or zinc finish has a 12 month warranty. C) Any ancillary components and parts (e.g. washers, bolts, spacers, etc.) which are not part of the sub-assembly, carry a 12 month warranty. D) This Warranty is provided only to the original purchaser/consumer, and on the original installation. Warranty is not transferable. Product failure or breakage due to accident/wreck or improper installation is not covered.

Warranty / Returns

Lighting Products

Incandescent Lighting:

All incandescent lighting products carry a limited 12 month warranty (from invoice date) against defects in material or workmanship. The limited 12 month warranty does not apply to several applications, such as, buses, construction equipment, and off road vehicles.

LED Lighting:

All LED lighting products carry a specific Limited Warranty (from invoice date) against defects in material or workmanship.

- LED with vehicle specific application is limited lifetime warranty to an original purchaser with receipt. Examples of lifetime warranty product: CTL5720LED CTL5720LED for 1957 Chevy, FTL3201LED-L for 1932 Ford.
- LED Marker, 2", 2-1/2", 4", 7", Oval & Square Lights - Varies from 2 years to 10 years to Limited Lifetime, depending on specific item. The housing, bezel or mounting base on any light made from Chrome/Stainless carries a 6 month limited warranty.
- LED Cab Lights and Kits, Double/Single Stud Turn Signal and PB/ KW/FL/VL or non-make Turn Signals and any/all Strip Lights - Varies from 2 years to 10 years to Limited Lifetime, depending on specific item. The housing, bezel or mounting base on any light made from Chrome/Stainless carries a 6 month limited warranty.
- LED Beacon, Driving, Headlights, Work & Warning Lights - Varies from 6 months to 3 years. The housing, bezel or mounting base on any light made from Chrome/Stainless carries a 6 month limited warranty.
- All LED Accessory Lights (Honda, Stainless Steel Double/Single face Lights, Interior Lights, License Plate Lights, and any Accent Lights. The housing, bezel or mounting base on any light made from Chrome/Stainless carries a 6 month limited warranty.
- For any product that contains any type of light or LED, whether it is a stand alone light or LED, or part of a larger assembled item (e.g.. Rear light panel), modifying electrical wiring, sockets, lighting pigtailed and any electrical connection from the original configuration will void the warranty of both wiring, pigtail and the light or LED unit and cannot be warrantied.

Returns

General Policy

All returns must be authorized by UPI. All return requests must be faxed or e-mailed (returns@upauto.com). A RMA number (Return Merchandise Authorization Number) will be provided. Returns not possessing a valid RMA number are subject to rejection and will be returned to sender at the dealer's expense.

All dealers are encouraged to use the Warranty RMA Claim Form and Dealer Portal Dashboard.

Defective Goods / Warranty Return

UPI offers our dealers a No Hassle Warranty Return. Please follow the instructions below for requesting a RMA for defective goods:

1. If any warranty issues occur, simply contact the UPI for RMA number. To make it easy for you we have three acceptable methods for requesting the RMA.

- Dealer Portal Dashboard: UPtruckparts.com/profile/login
- Email: returns@upauto.com
- Fax: 888-986-5988

Note: To ensure you receive a timely RMA credit, we cannot accept RMA requests by phone.

2. You will be required to provide the following information:
 - Your business name
 - Contact name and telephone number (in case we have questions)
 - A list of the defective item number and quantity with the nature/reason of the defect
 - Special instructions you have for us
 - The enclosed fax form may be used for your convenience to request an RMA
3. UPI will review the request to ensure the products are within the stated warranty period.
4. Once we have validated the warranty items, a RMA confirmation, listing the items and cost will be faxed to the dealer within 3 business days. UPI will process the credit to your account within 30 days.

Note:

The majority of time there will be no need to return the warranty product to us.

However, from time to time, UPI may require some warranty products to be shipped back so

we may analyze the cause of the failure. All warranty products that are required to be shipped back will be freight prepaid by UPI.

Stock Return - USA Only

United Pacific Industries encourages all dealers to regularly monitor the sales volume and stock level of their inventory items. As sales trends may slow the movement of specific items, our hope is that those items are featured as "close-out specials" as to minimize stock returns. We also understand that the dealer, from time to time, may accumulate over-stock items and desire to return those. Therefore, we have adopted the following policy below.

NOTE:

Items must have been purchased by the United States dealer requesting the stock return.
Items must have been purchased within the preceding 12 months.
Items that have been discontinued will not be considered for return.

1. Contact the United Pacific for RMA number.

We have 3 acceptable methods for requesting the RMA:

- Dealer Portal Dashboard: UPtruckparts.com/profile/login
- Email: returns@upauto.com
- Fax: 888-986-5988

Note: To ensure you receive a timely RMA credit, we cannot accept RMA requests by phone.

2. You will be required to provide the following information:

- Your business name.
- Contact name and telephone number (in case we have questions).
- A list of the defective item number and quantity with the nature/reason of the defect.
- Special instructions you have for us.

3. Your claim will be reviewed within 5 business days and you will be contacted by your sales representative who will discuss solutions to liquidate these slow moving items.

4. In the event United Pacific and the dealer agree to a credit in lieu of returning the items, this credit will be issued within 10 business days.

5. In the event items are returned by the dealer, United Pacific will issue an RMA number to the dealer. Once the RMA is issued, the following conditions will apply:

- Returned items are subject to a 20% re-stocking fee.
- Return shipping costs are the responsibility of the dealer.
- Items must not have any retail/price sticker on exterior package/box/card or they will be returned to the dealer at dealer's expense and no credit given.
- Items must be in good condition with original packaging intact, unblemished and in re-sellable condition, or they will be returned to the dealer at dealer's expense and no credit given.
- Allow up to 30 days for the credit to be issued from the time the returned items are received.

6. Stock returns may be requested throughout the year and are subject to final approval by United Pacific.

Closeout / Discontinue

UPI will not warranty or accept returns on Closeout/Discontinue items.

Procedure:

An inventory of the merchandise being returned must accompany each return.
The RMA number should be prominently displayed on each carton/box.

All Returns must be returned freight prepaid.

Ship Returns to:

United Pacific Industries
Attn: Returns Department
3788 E. Conant St.
Long Beach, CA 90808

RMA:

Outstanding RMA's will be automatically canceled if not used within 30 days of issuance.
Go to the Dealer Portal Guide Page for more information on RMA procedure.

Disclaimer

United Pacific Industries reserves the right to amend or update our Policies & Procedures without notice.

United Pacific Industries is not responsible for typographical, product information or print errors. Specifications on this catalog may be changed without advance notice. Products may look different from those in the photos on this catalog due to printing quality.



United Pacific

3788 E. CONANT STREET
 LONG BEACH, CA 90808
 TEL: (562) 421-3888
 FAX: (888) 986-5988
 TOLL FREE: (800) 790-6988
 UPauto.com

DEFECTIVE GOODS / WARRANTY CLAIM FORM

Date: _____
 Company Name: _____
 Address: _____
 City, State, Zip: _____
 Contact Name: _____
 Phone Number: _____
 Fax Number: _____
 Email: _____

List defective items below:

Item#	Qty	Description	Reason for Defect	Date Sold to Customer

Any special notes / instructions for United Pacific (list here):

File your claim at:
 by email - sales@upauto.com
 by fax - (888) 986-5988

Internal Use Only	
Date Received: _____	Final RMA: _____
RMA Approval Date: _____	Credit Amount: _____
RMA Number: _____	Approved by: _____

CALIFORNIA PROPOSITION 65 WARNING



WARNING: Cancer & Reproductive Harm-
www.P65Warnings.ca.gov

INDEX

ITEM #	PAGE #
<u>10927</u>	<u>32</u>
<u>20518</u>	<u>19</u>
<u>20562</u>	<u>18</u>
<u>20563</u>	<u>30</u>
<u>20565</u>	<u>19</u>
<u>20567</u>	<u>30</u>
<u>20568</u>	<u>30</u>
<u>20570</u>	<u>30</u>
<u>20572</u>	<u>18</u>
<u>20583</u>	<u>28</u>
<u>20584</u>	<u>18</u>
<u>20585</u>	<u>18</u>
<u>20610</u>	<u>20</u>
<u>20671</u>	<u>46</u>
<u>20676</u>	<u>46</u>
<u>20695</u>	<u>13</u>
<u>20873</u>	<u>46</u>
<u>20874</u>	<u>47</u>
<u>20875</u>	<u>46</u>
<u>20876</u>	<u>47</u>
<u>20877</u>	<u>47</u>
<u>20878</u>	<u>48</u>
<u>20879</u>	<u>47</u>
<u>20880</u>	<u>47</u>
<u>20881</u>	<u>48</u>
<u>20882</u>	<u>48</u>
<u>20883</u>	<u>48</u>
<u>20884</u>	<u>48</u>
<u>21061</u>	<u>11</u>
<u>21062</u>	<u>11</u>
<u>21063</u>	<u>11</u>

ITEM #	PAGE #
<u>21064</u>	<u>11</u>
<u>21151</u>	<u>12</u>
<u>21152</u>	<u>12</u>
<u>21153</u>	<u>12</u>
<u>21154</u>	<u>12</u>
<u>21157</u>	<u>42</u>
<u>21160</u>	<u>13</u>
<u>21160</u>	<u>31</u>
<u>21161</u>	<u>31</u>
<u>21162</u>	<u>31</u>
<u>21165</u>	<u>13</u>
<u>21166</u>	<u>13</u>
<u>21538</u>	<u>45</u>
<u>21539</u>	<u>45</u>
<u>21540</u>	<u>45</u>
<u>21551</u>	<u>45</u>
<u>21552</u>	<u>45</u>
<u>21718</u>	<u>19</u>
<u>21719</u>	<u>10</u>
<u>21720</u>	<u>32</u>
<u>21724</u>	<u>10</u>
<u>21741</u>	<u>19</u>
<u>21904</u>	<u>45</u>
<u>28002</u>	<u>26</u>
<u>28006</u>	<u>16</u>
<u>28008</u>	<u>16</u>
<u>28009</u>	<u>16</u>
<u>28011</u>	<u>17</u>
<u>28013</u>	<u>26</u>
<u>28015</u>	<u>17</u>
<u>29000</u>	<u>15</u>

ITEM #	PAGE #
<u>29001</u>	<u>14</u>
<u>29002</u>	<u>14</u>
<u>29003</u>	<u>14</u>
<u>29004</u>	<u>25</u>
<u>29005</u>	<u>24</u>
<u>29006</u>	<u>24</u>
<u>29009</u>	<u>25</u>
<u>29010</u>	<u>25</u>
<u>29011</u>	<u>25</u>
<u>29012</u>	<u>36</u>
<u>29013</u>	<u>36</u>
<u>29014</u>	<u>36</u>
<u>29015</u>	<u>41</u>
<u>29016</u>	<u>41</u>
<u>29017</u>	<u>41</u>
<u>29018</u>	<u>15</u>
<u>29019</u>	<u>15</u>
<u>29020</u>	<u>22</u>
<u>29022</u>	<u>21</u>
<u>29023</u>	<u>21</u>
<u>29024</u>	<u>22</u>
<u>29025</u>	<u>23</u>
<u>29026</u>	<u>21</u>
<u>29027</u>	<u>22</u>
<u>29028</u>	<u>22</u>
<u>29040</u>	<u>32</u>
<u>29041</u>	<u>27</u>
<u>29042</u>	<u>28</u>
<u>29043</u>	<u>26</u>
<u>29044</u>	<u>27</u>
<u>29045</u>	<u>30</u>

INDEX

ITEM #	PAGE #
<u>29046</u>	<u>21</u>
<u>29046</u>	<u>29</u>
<u>29047</u>	<u>34</u>
<u>29048</u>	<u>33</u>
<u>29049</u>	<u>35</u>
<u>29050</u>	<u>34</u>
<u>29051</u>	<u>33</u>
<u>29052</u>	<u>33</u>
<u>29053</u>	<u>34</u>
<u>29054</u>	<u>34</u>
<u>29055</u>	<u>5</u>
<u>29056</u>	<u>32</u>
<u>29057</u>	<u>31</u>
<u>29060</u>	<u>38</u>
<u>29061</u>	<u>37</u>
<u>29062</u>	<u>37</u>
<u>29063</u>	<u>37</u>
<u>29064</u>	<u>37</u>
<u>29065</u>	<u>38</u>
<u>29066</u>	<u>38</u>
<u>29067</u>	<u>38</u>
<u>29068</u>	<u>39</u>
<u>29070</u>	<u>41</u>
<u>29071</u>	<u>42</u>
<u>29072</u>	<u>42</u>
<u>29073</u>	<u>42</u>
<u>29090</u>	<u>6</u>
<u>29091</u>	<u>7</u>
<u>29092</u>	<u>7</u>
<u>29093</u>	<u>7</u>
<u>29094</u>	<u>7</u>

ITEM #	PAGE #
<u>29095</u>	<u>20</u>
<u>29096</u>	<u>20</u>
<u>29097</u>	<u>6</u>
<u>29098</u>	<u>10</u>
<u>29100</u>	<u>5</u>
<u>29102</u>	<u>26</u>
<u>29103</u>	<u>29</u>
<u>29105</u>	<u>27</u>
<u>29108</u>	<u>29</u>
<u>29109</u>	<u>24</u>
<u>29110</u>	<u>32</u>
<u>29112</u>	<u>28</u>
<u>29113</u>	<u>35</u>
<u>29115</u>	<u>27</u>
<u>29116</u>	<u>33</u>
<u>29118</u>	<u>31</u>
<u>29119</u>	<u>29</u>
<u>29120</u>	<u>35</u>
<u>29121</u>	<u>35</u>
<u>29122</u>	<u>24</u>
<u>29123</u>	<u>40</u>
<u>29124</u>	<u>40</u>
<u>29125</u>	<u>40</u>
<u>29126</u>	<u>40</u>
<u>29128</u>	<u>16</u>
<u>29129</u>	<u>17</u>
<u>29130</u>	<u>15</u>
<u>29131</u>	<u>23</u>
<u>29132</u>	<u>23</u>
<u>29133</u>	<u>20</u>
<u>29134</u>	<u>14</u>

ITEM #	PAGE #
<u>29135</u>	<u>21</u>
<u>29136</u>	<u>23</u>
<u>29139</u>	<u>39</u>
<u>29141</u>	<u>36</u>
<u>29142</u>	<u>43</u>
<u>29143</u>	<u>43</u>
<u>29144</u>	<u>43</u>
<u>29145</u>	<u>43</u>
<u>29146</u>	<u>44</u>
<u>29147</u>	<u>9</u>
<u>29148</u>	<u>9</u>
<u>29150</u>	<u>5</u>
<u>29151</u>	<u>8</u>
<u>29152</u>	<u>8</u>
<u>29153</u>	<u>10</u>
<u>42374</u>	<u>9</u>
<u>42375</u>	<u>9</u>
<u>42376</u>	<u>9</u>
<u>42377</u>	<u>9</u>
<u>80000</u>	<u>44</u>
<u>80000</u>	<u>44</u>
<u>80002</u>	<u>28</u>
<u>80003</u>	<u>17</u>
<u>80004</u>	<u>39</u>
<u>80004</u>	<u>42</u>
<u>21721B</u>	<u>30</u>
<u>21722B</u>	<u>30</u>
<u>21723B</u>	<u>20</u>
<u>41667B</u>	<u>39</u>
<u>41668B</u>	<u>39</u>



United Pacific

UPauto.com | T 800.790.6988 | F 888.986.5988

© 2022 United Pacific Industries. All rights reserved. Products not shown to scale. Specifications subject to change without notice.

UCSS2

Truck Stainless Steel 2022 Catalog



710270064519